

Urkish/Mozan Shape Catalog

Phases 2-~~4~~³
Revised 2006

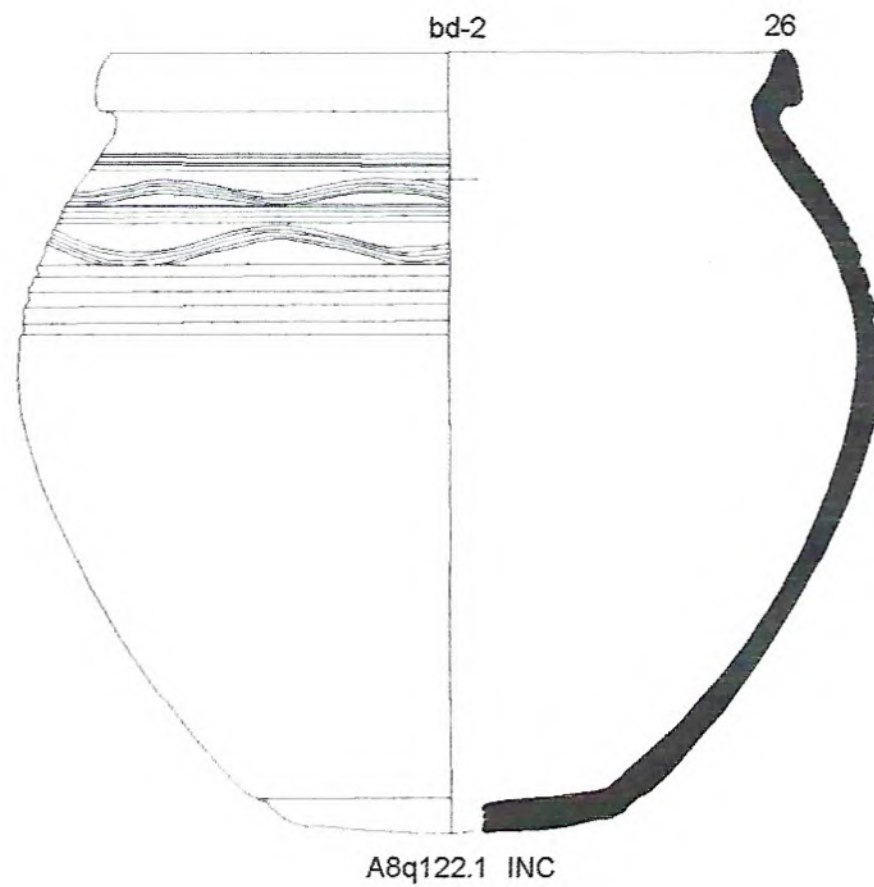

Marilyn Kelly-Buccellati

Round Profile Bowls

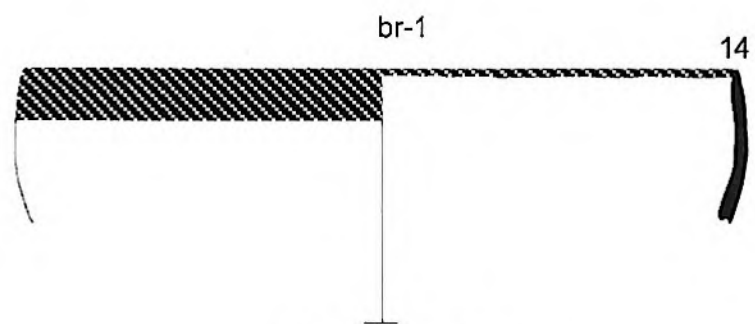

A1q904 BC f113

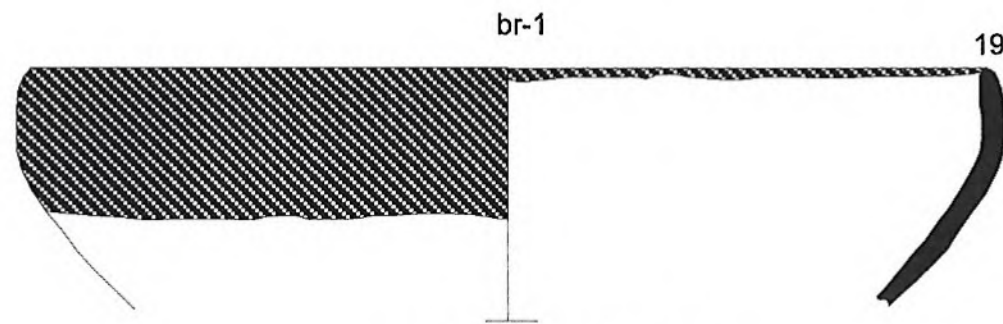

A10q218-p4 BC f66

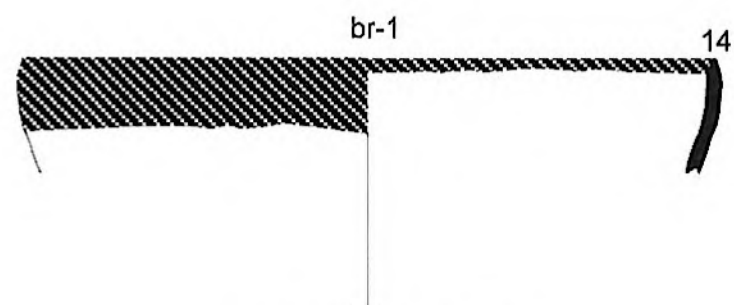

A7q116-p2 BC f30

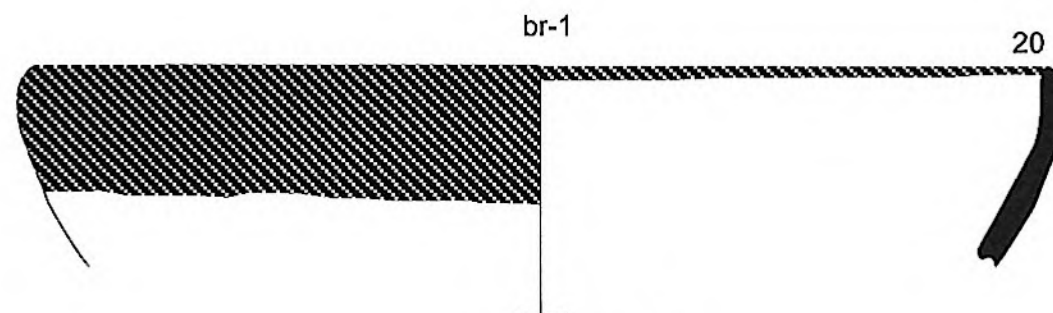

A6q1089.1 BC

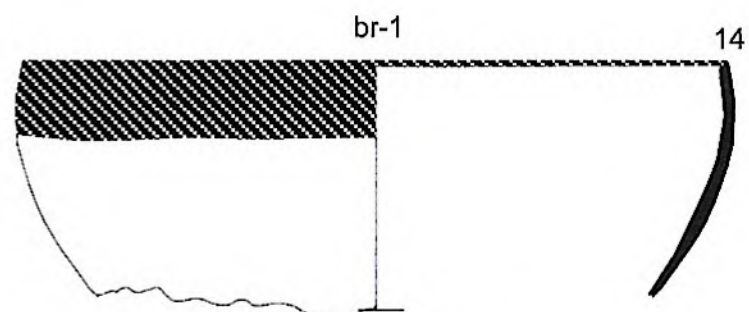

A5q703 BC f113

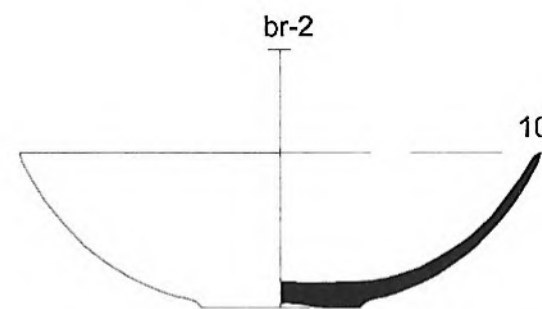

A1q915-p ROG f173

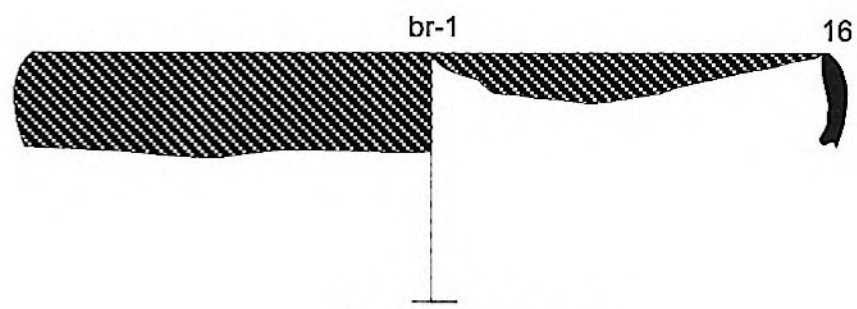

A6q569-p2 BC f176

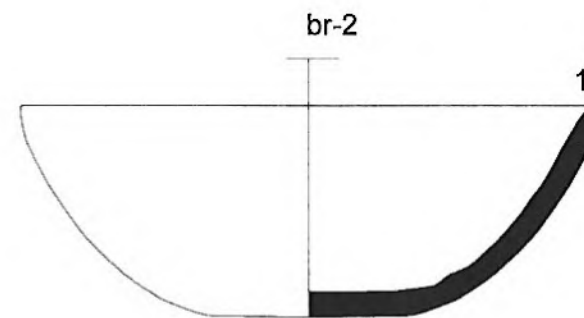

A1q1044 S f173

Round Profile Bowls

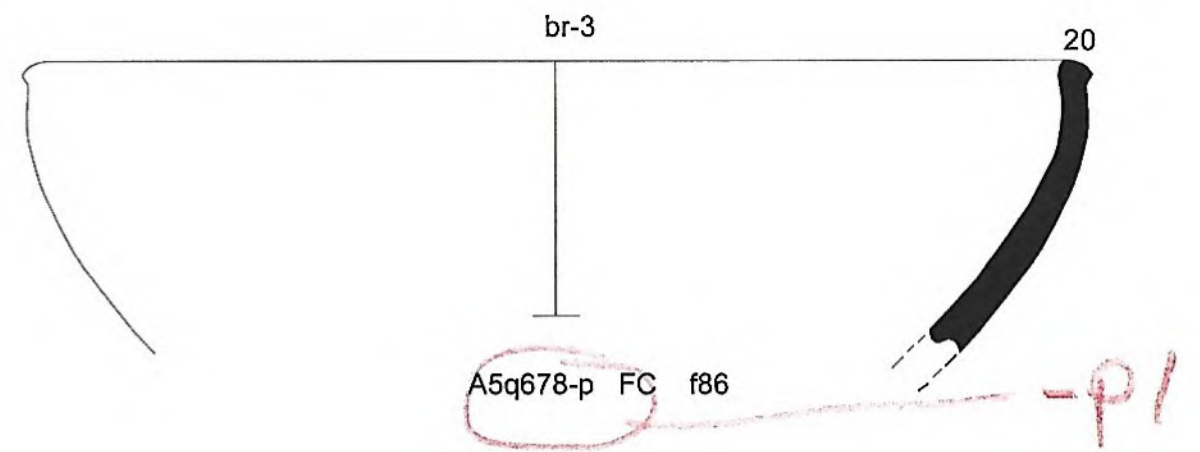
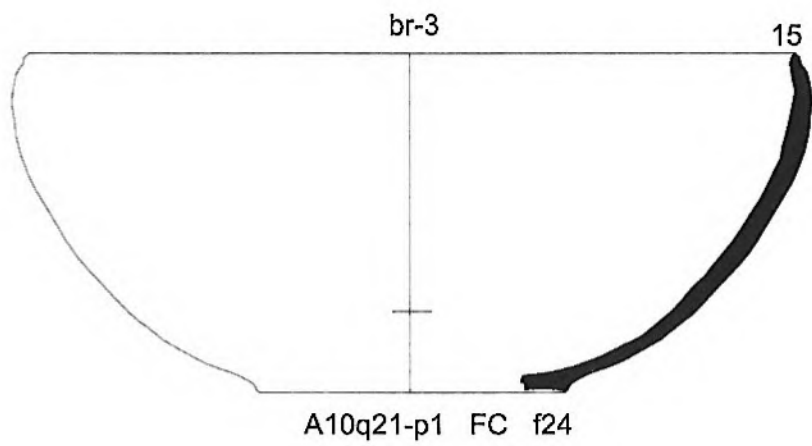
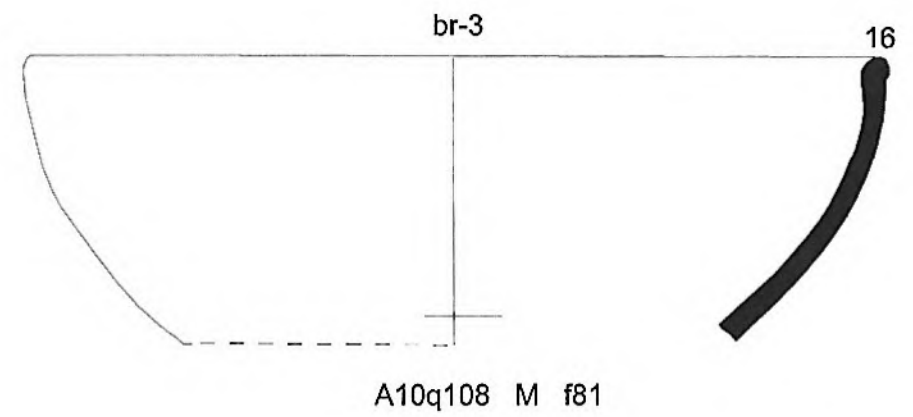
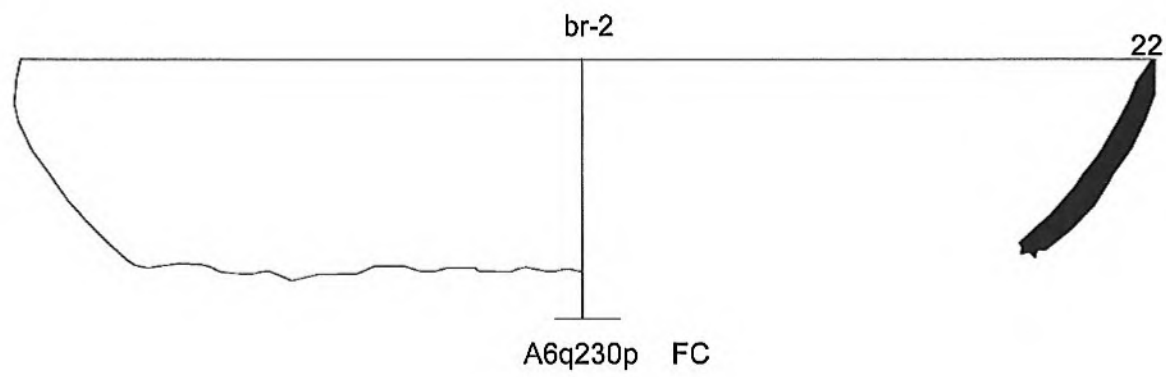
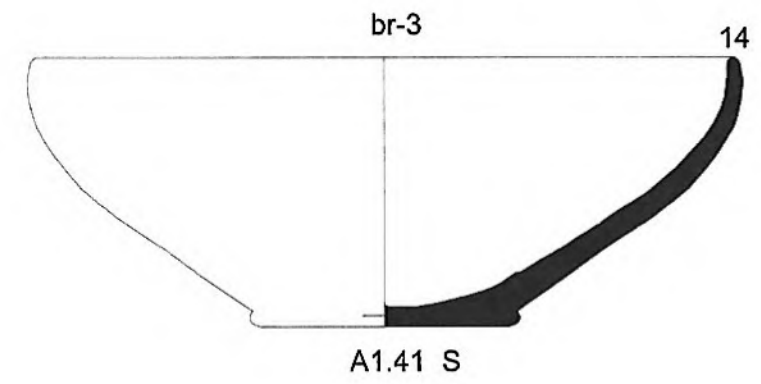
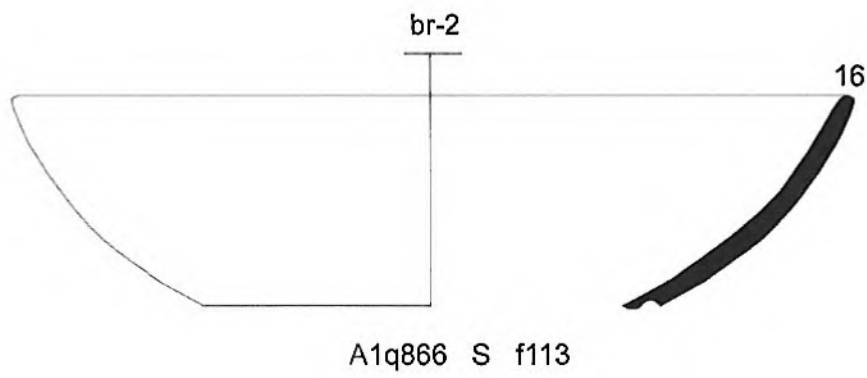
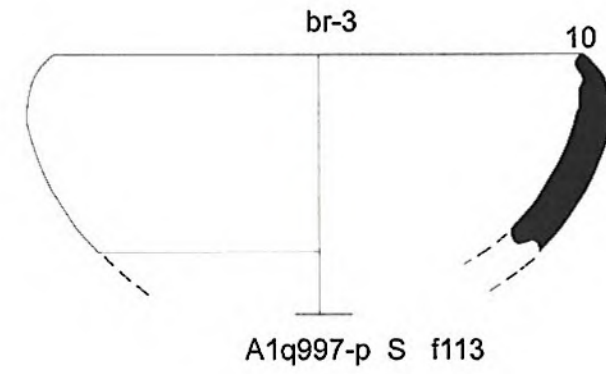
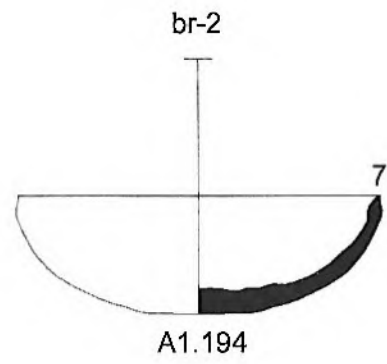

Round Profile Bowls

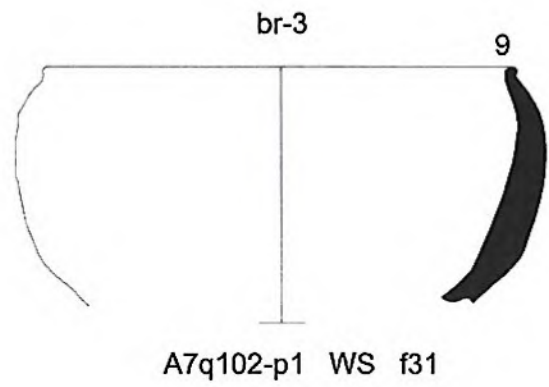
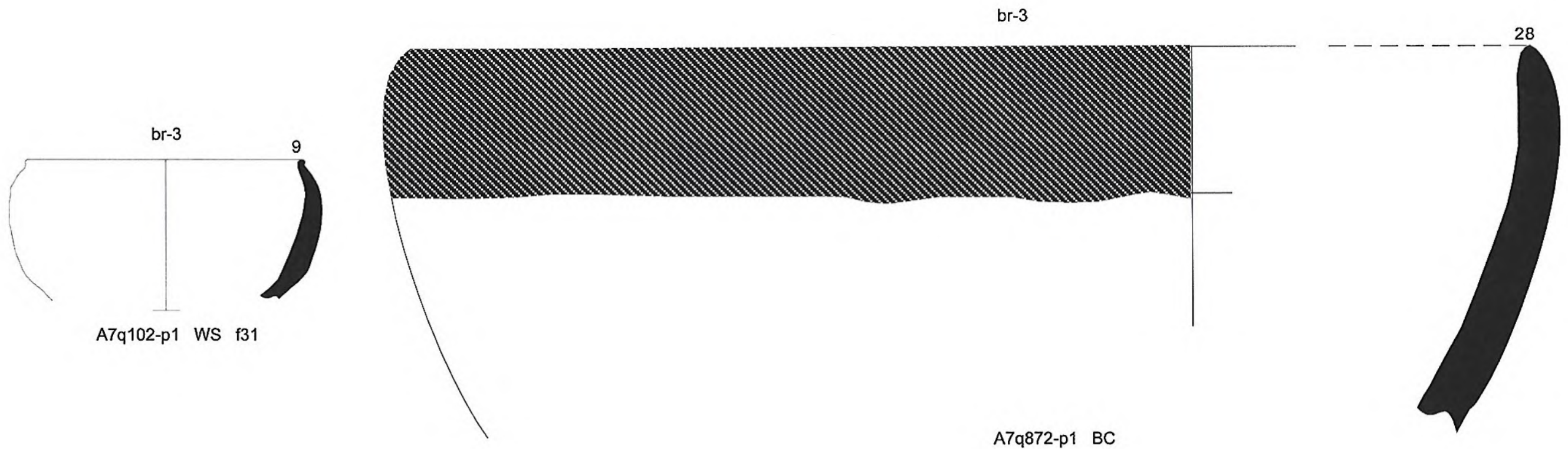
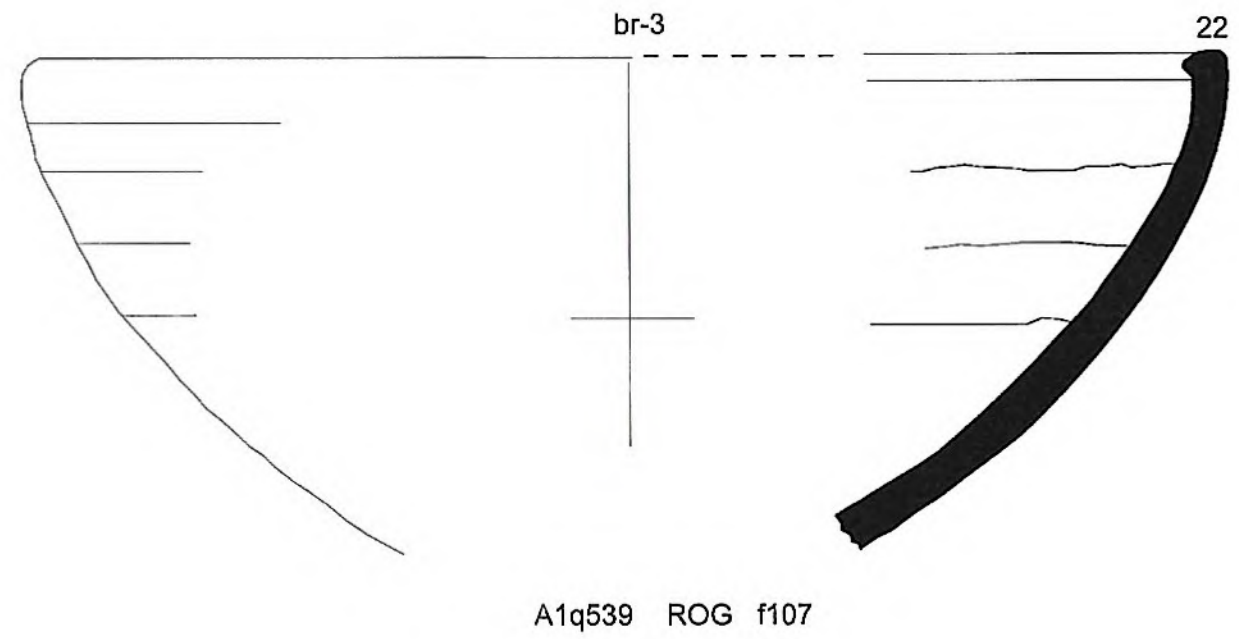
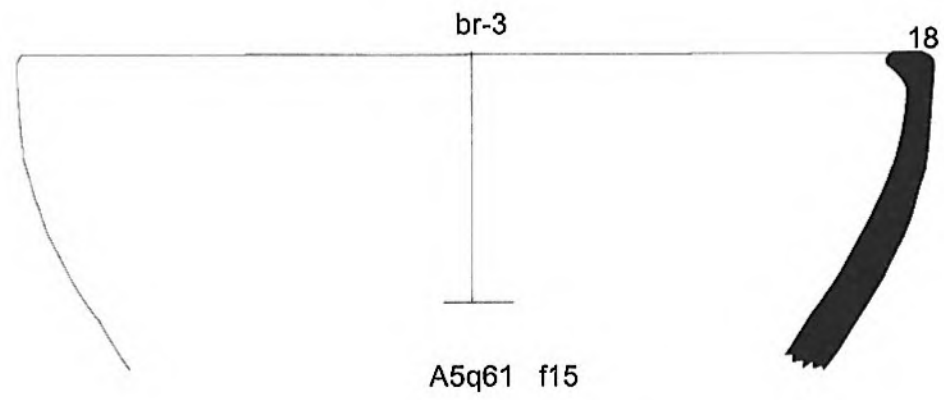
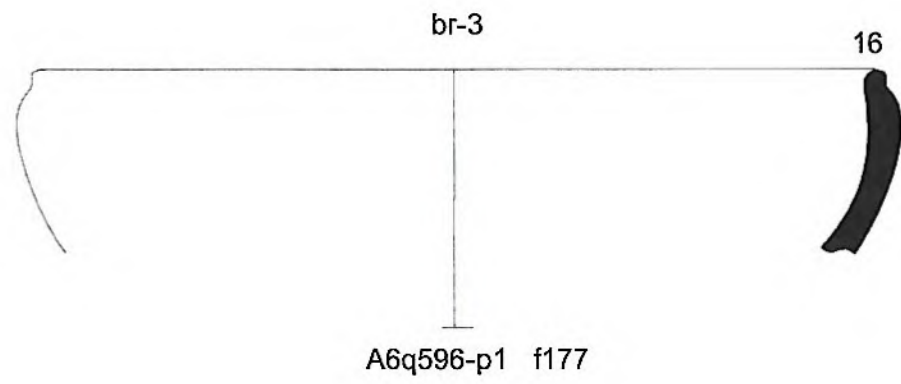

Round Profile Bowls

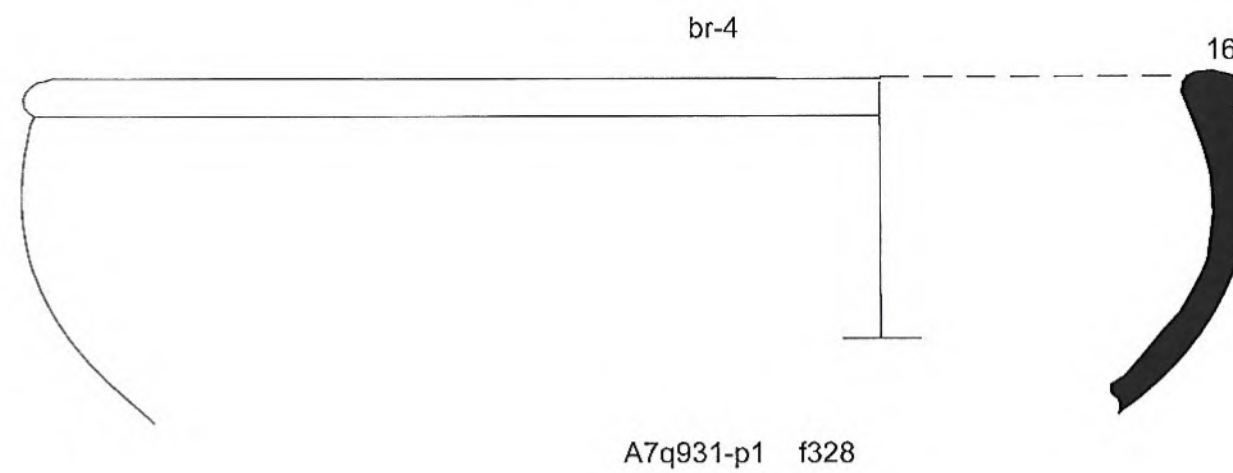
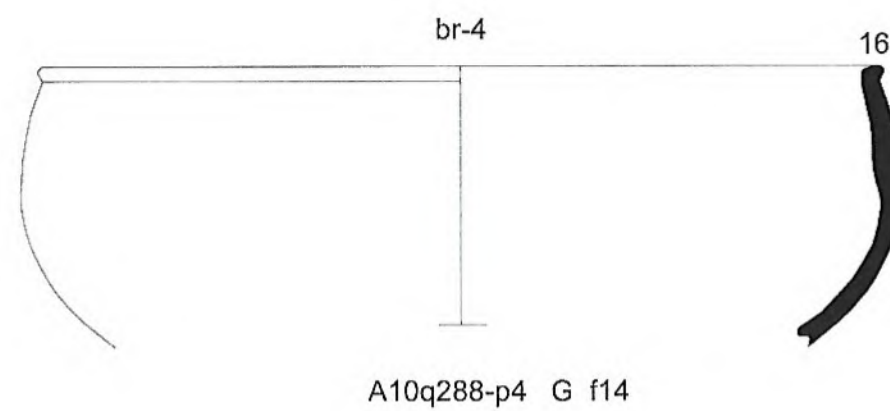
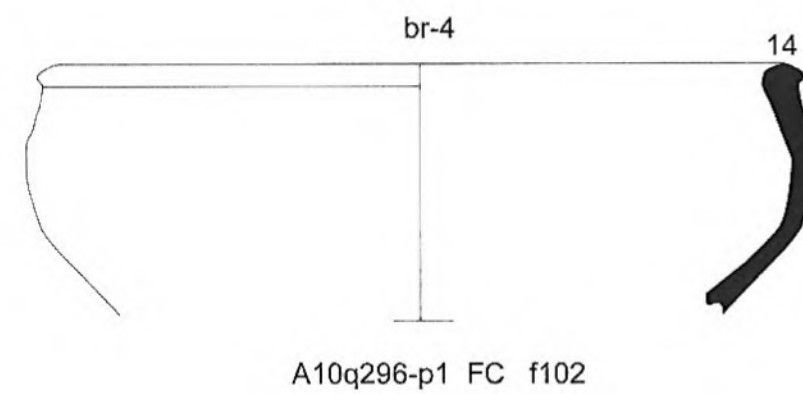
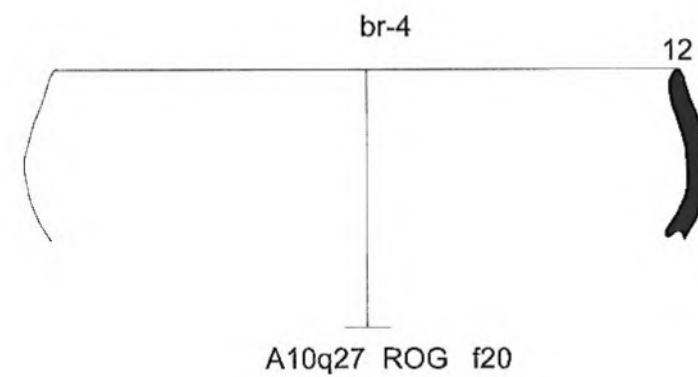
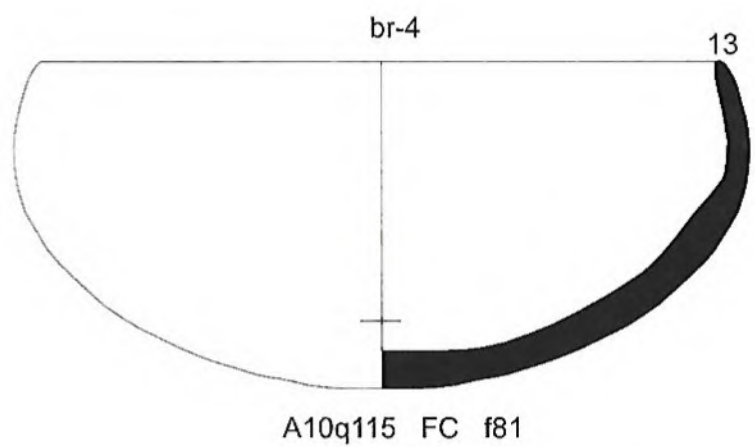
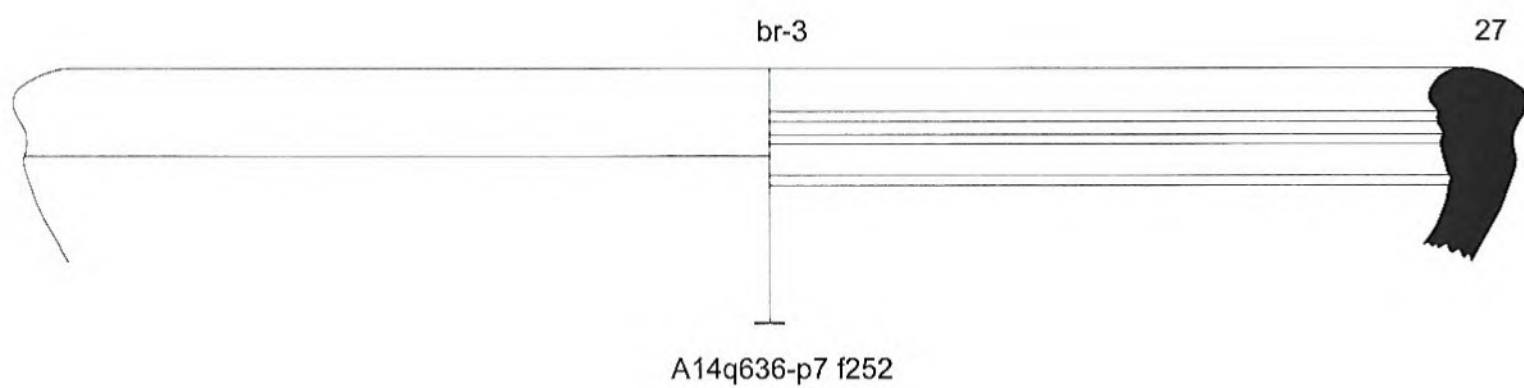
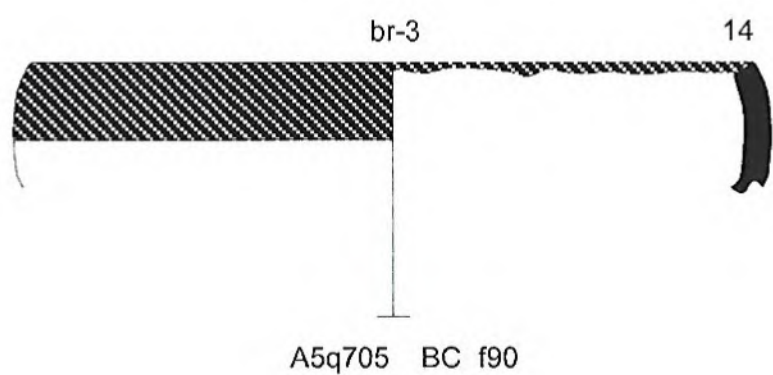
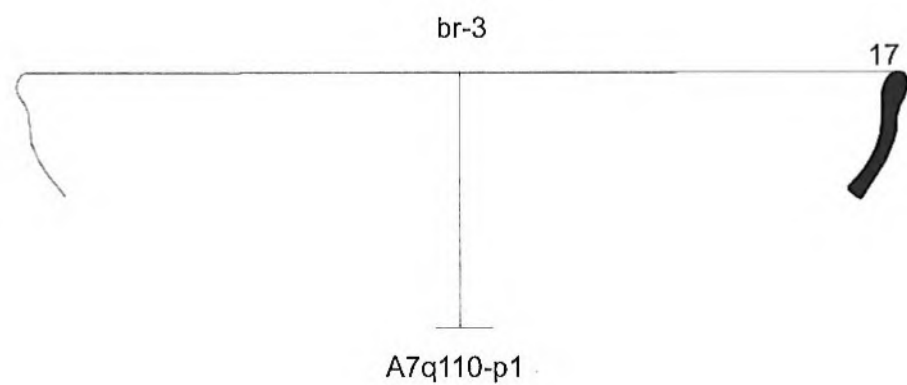

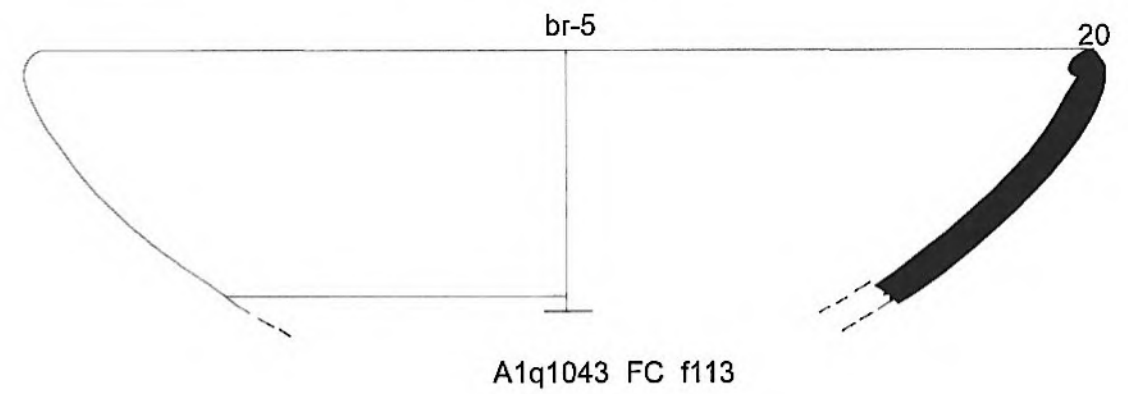
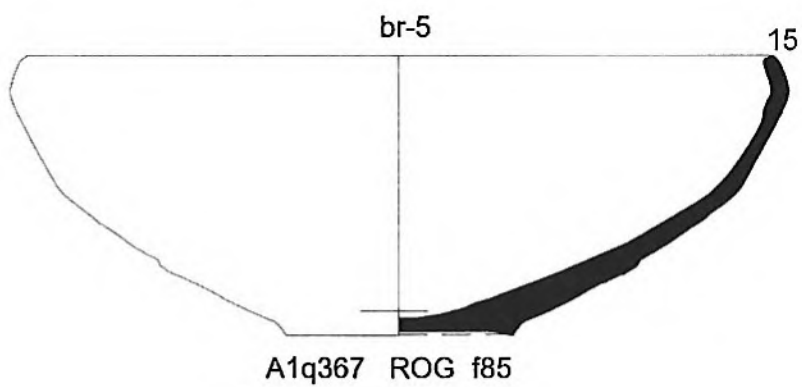
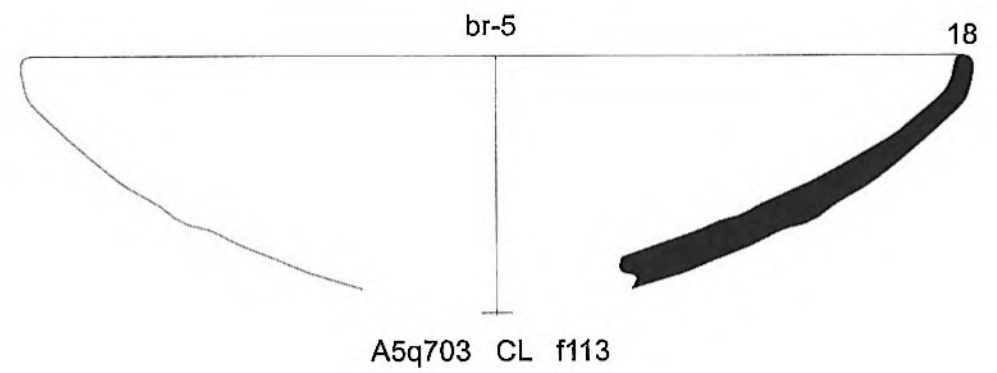
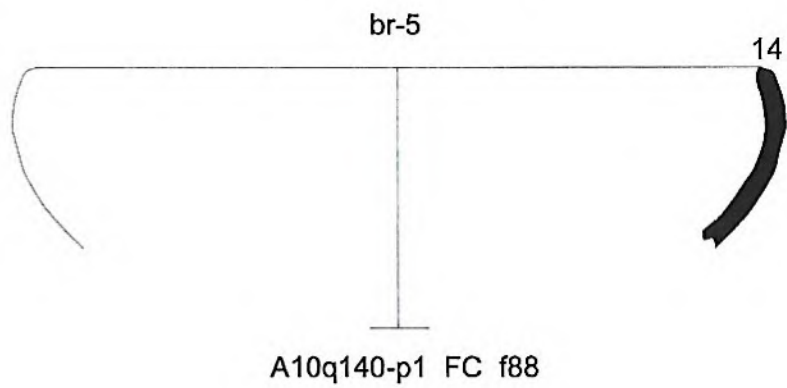
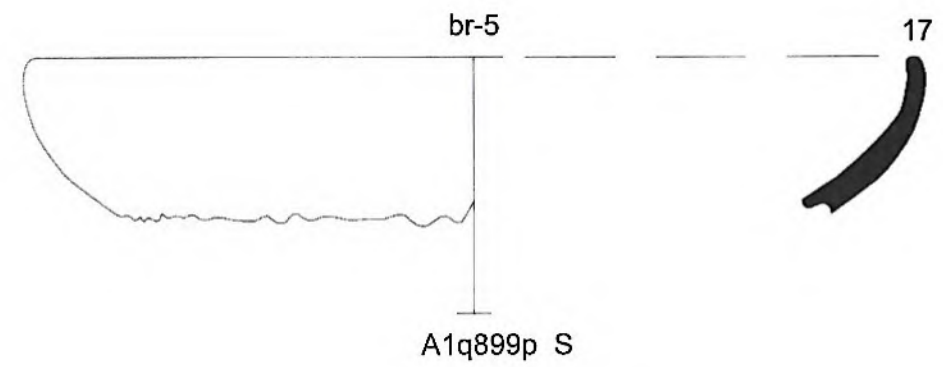
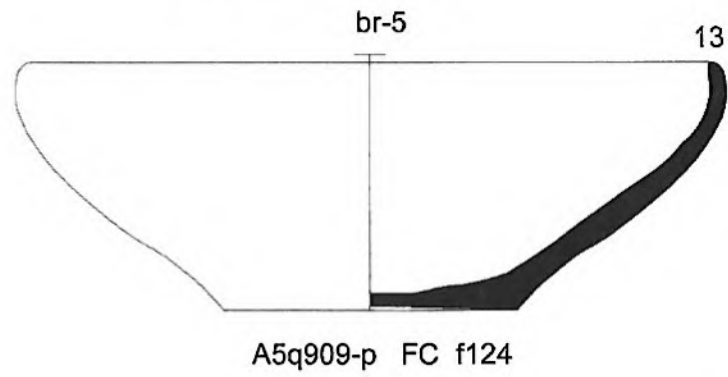
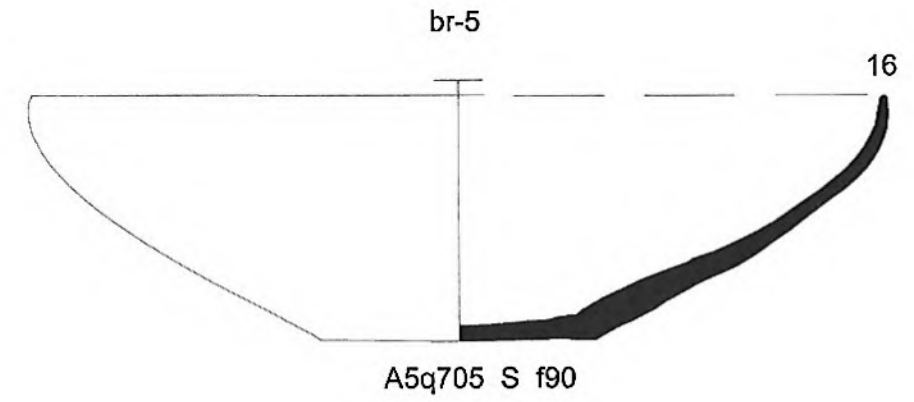
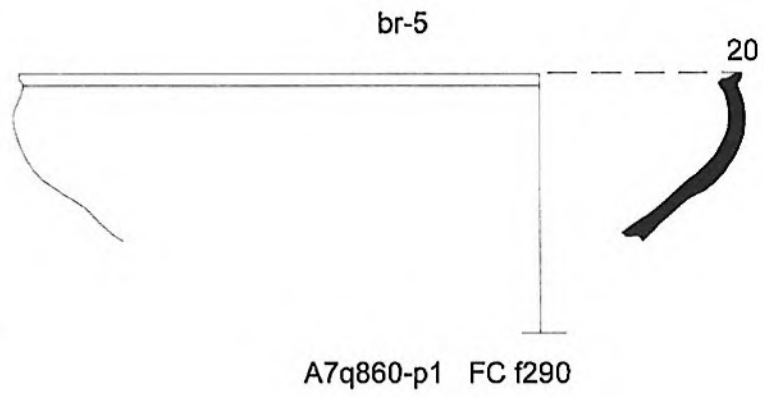

Round Profile Bowls

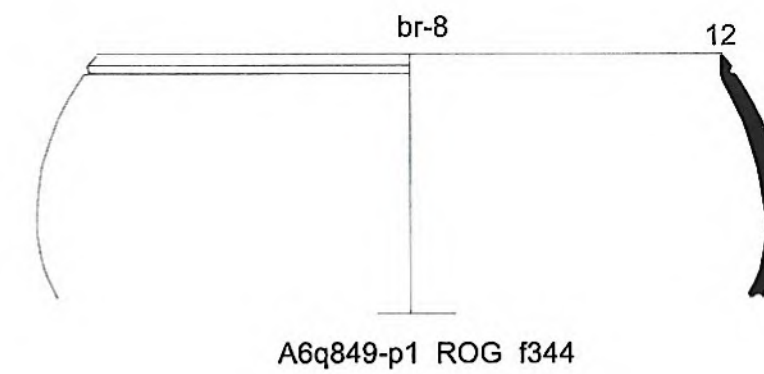
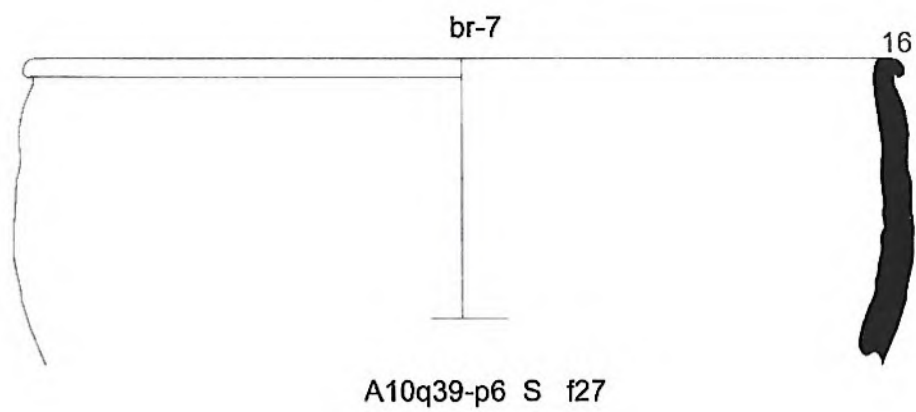
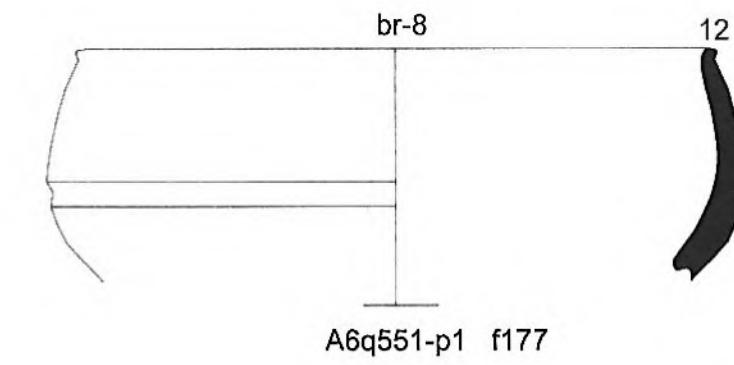
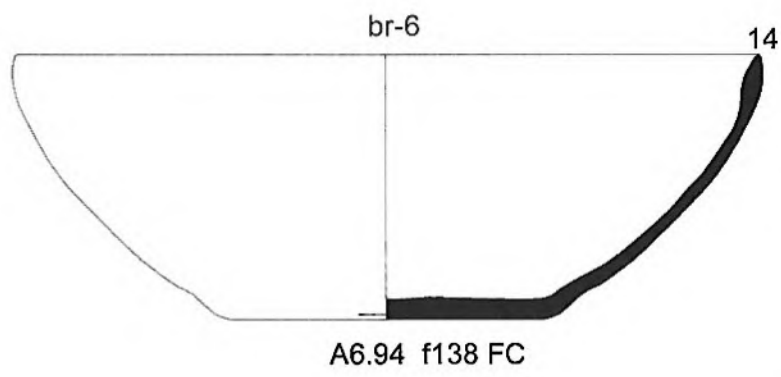
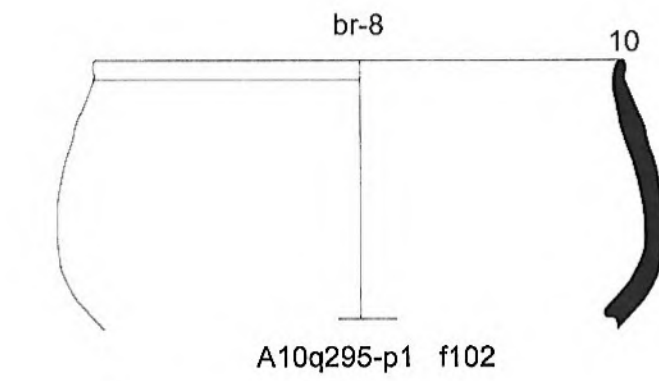
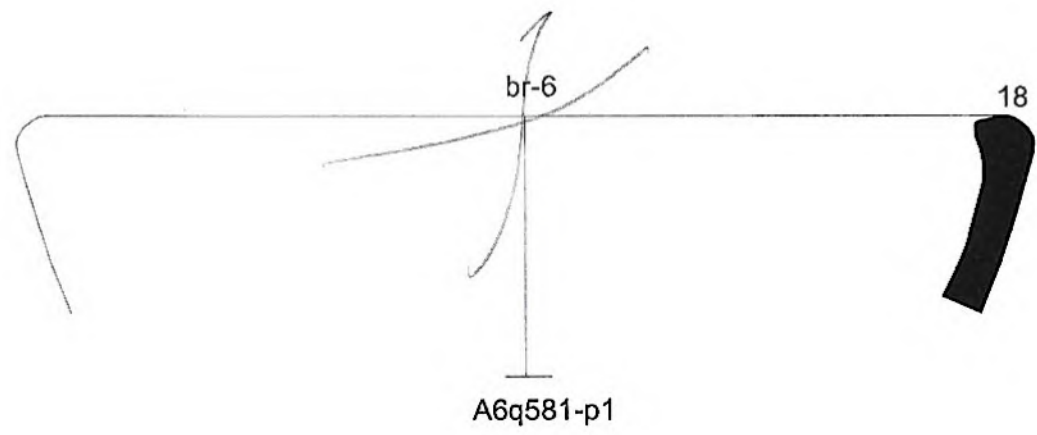
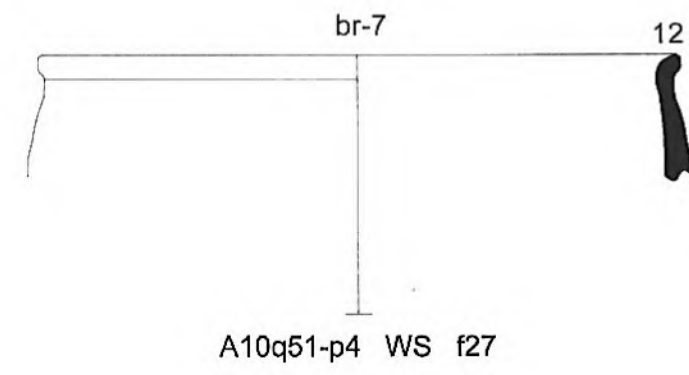
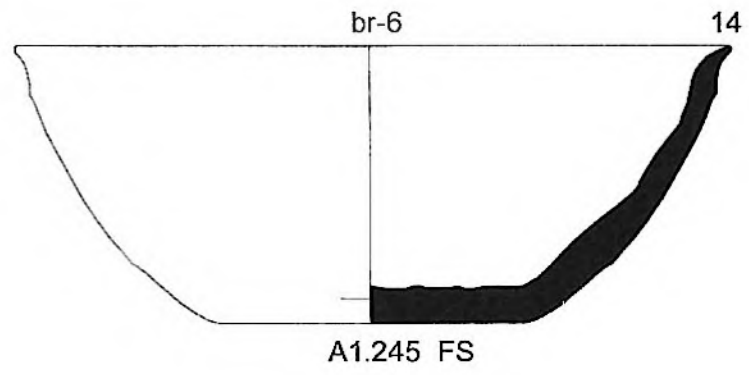

Round Profile Bowls

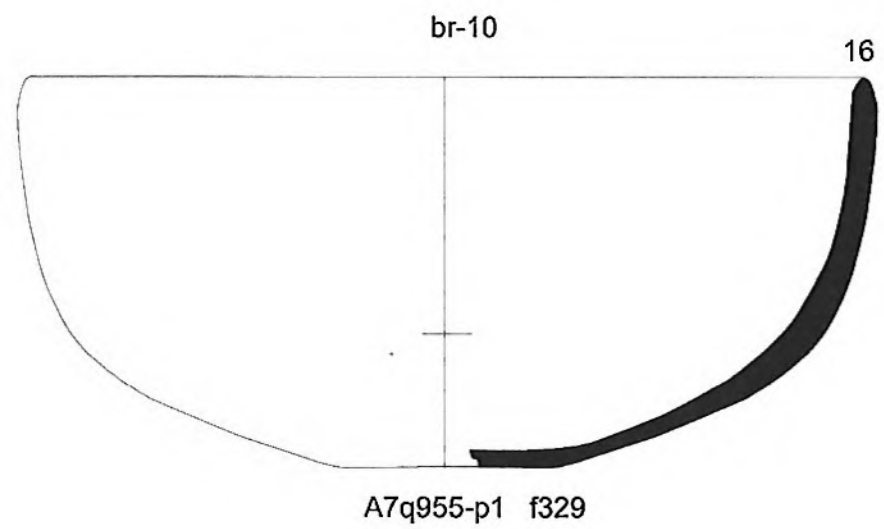
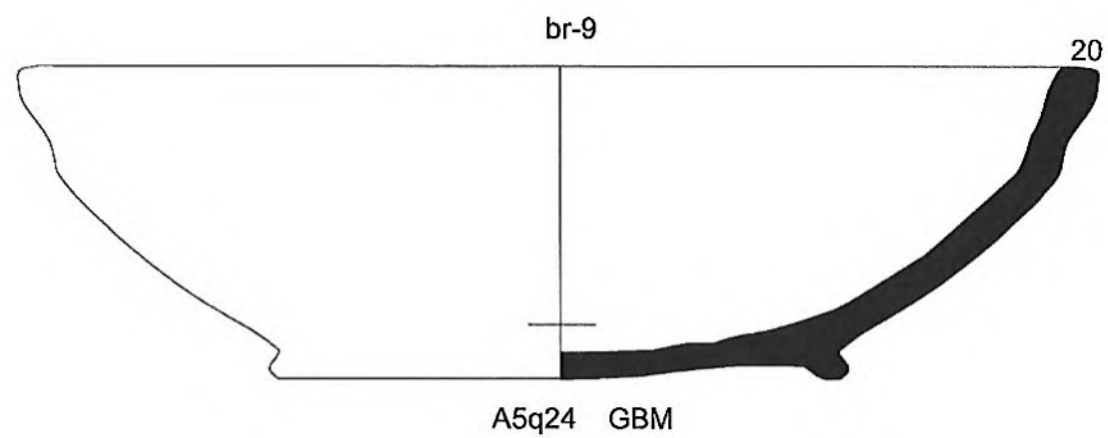

Straight Sided Bowls

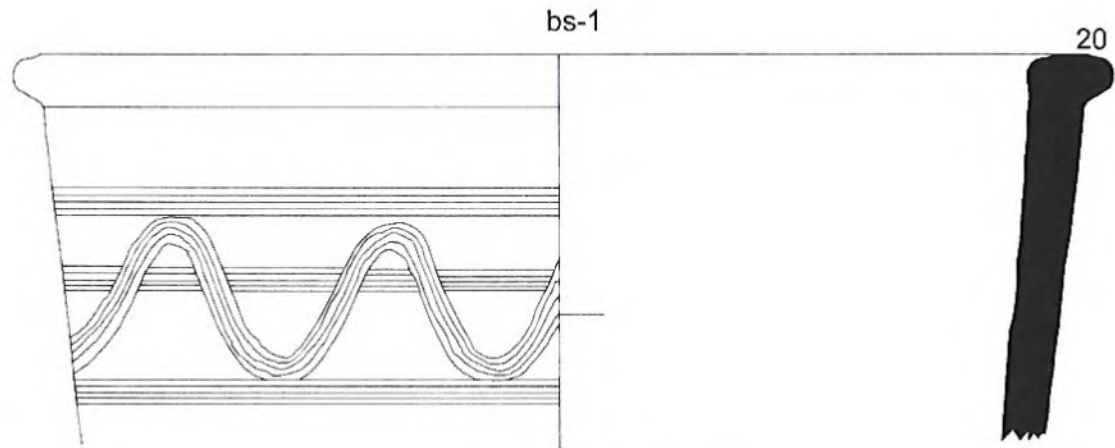

A1qp963-p INC f113

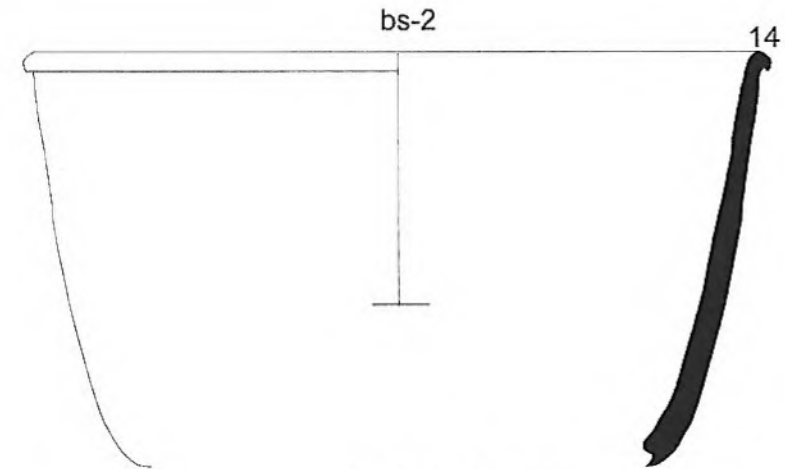

A7q877-p1 f288

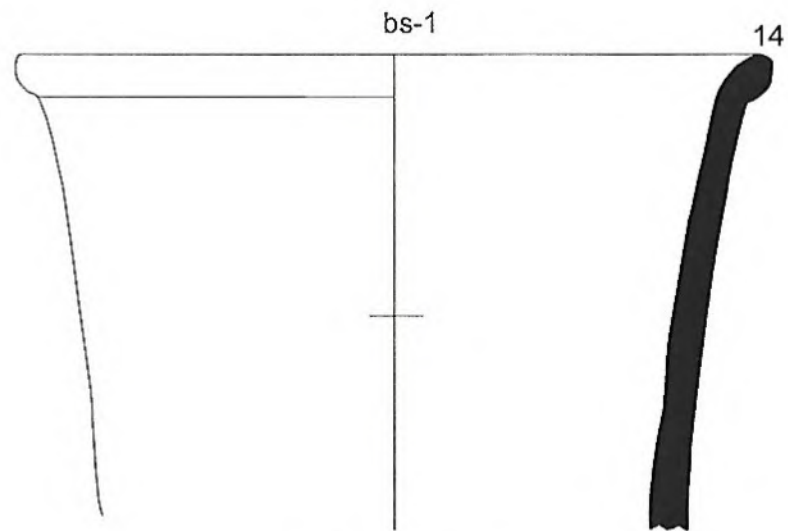

A1q864-p FC f113

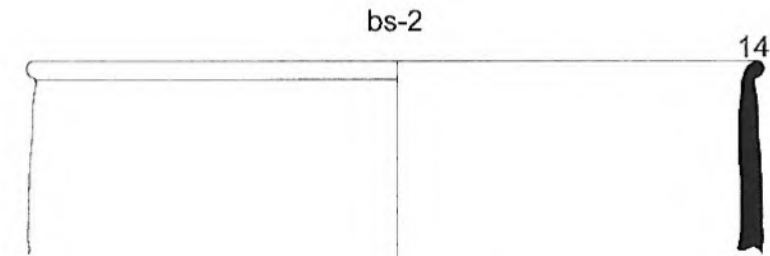

A10q158-p1 S f83

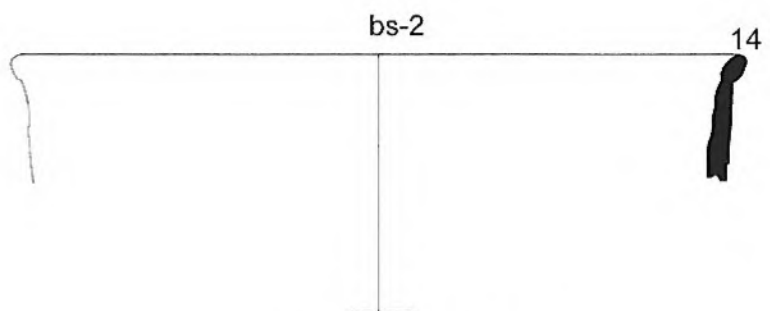

A6q472-p1 G f166

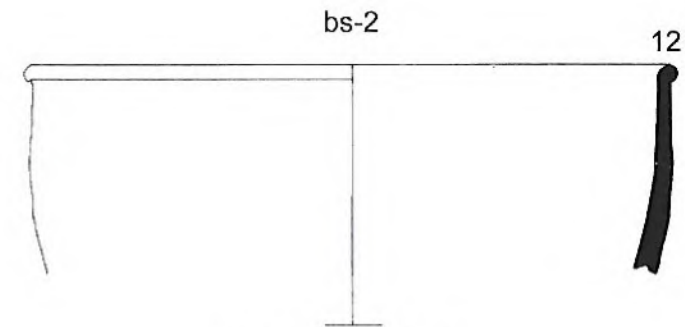

A10q143-p2 S f88

Straight Sided Bowls

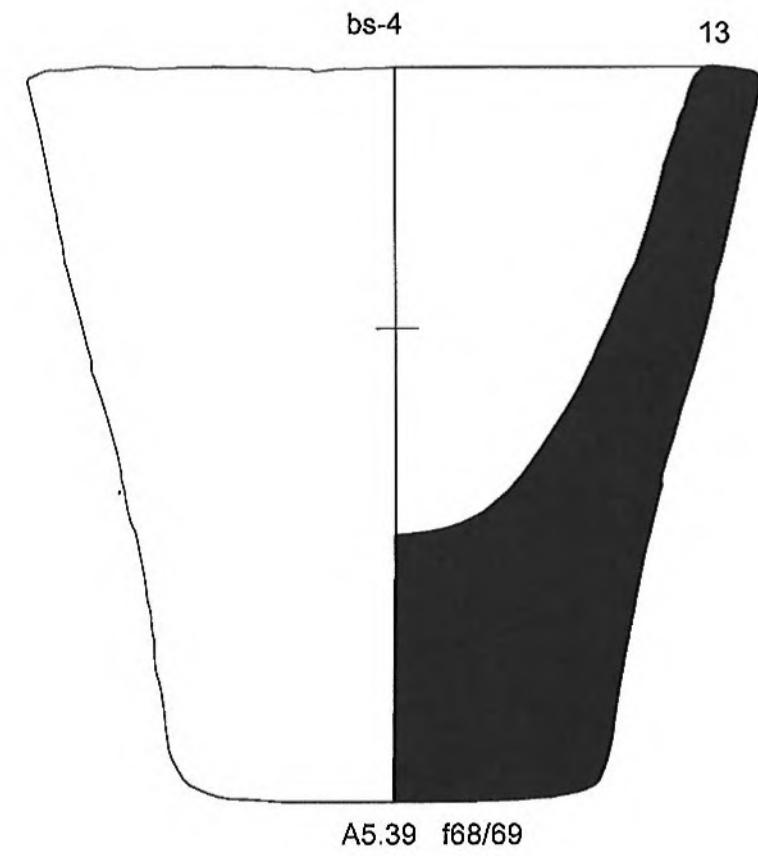
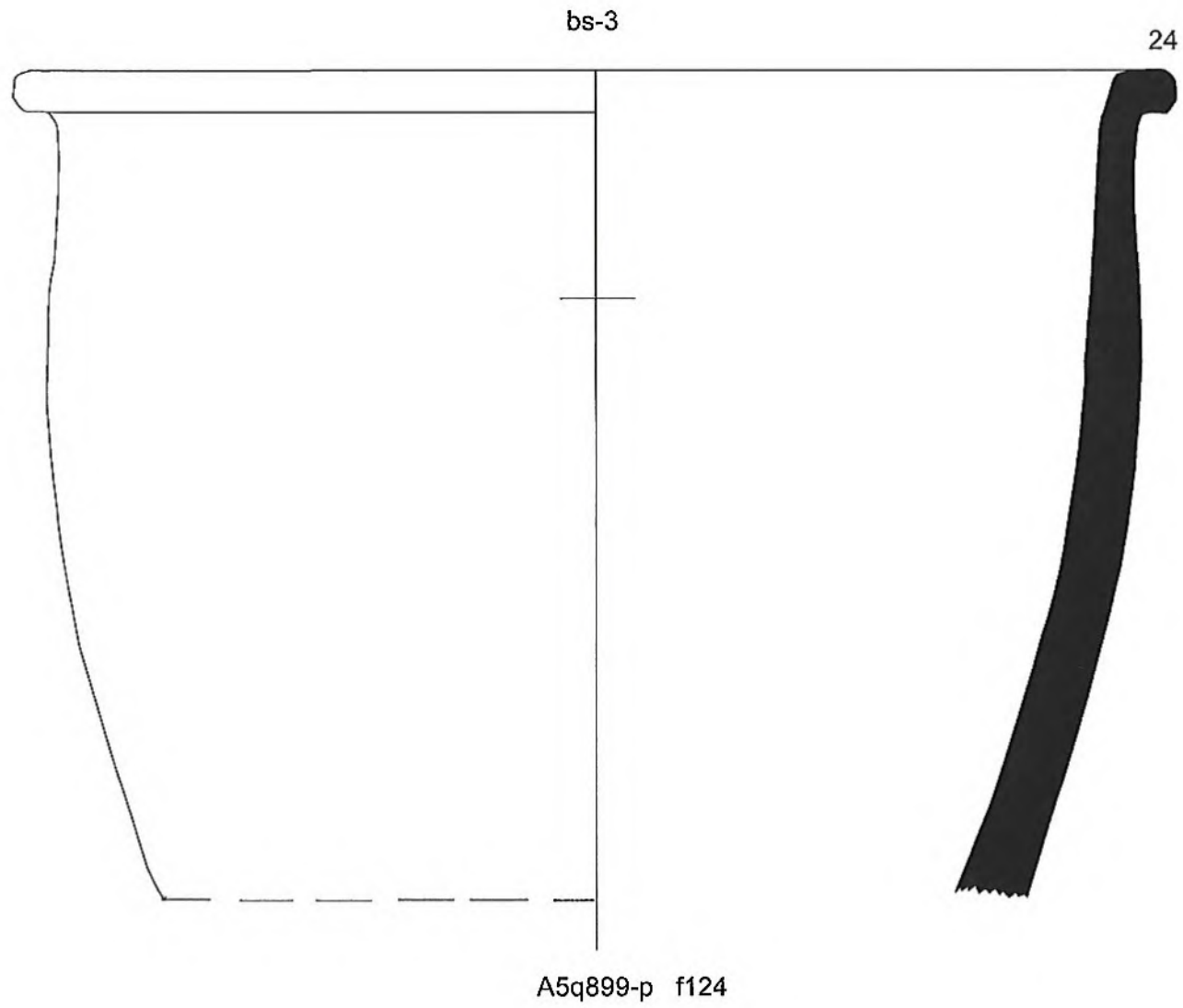

Straight Sided Bowls

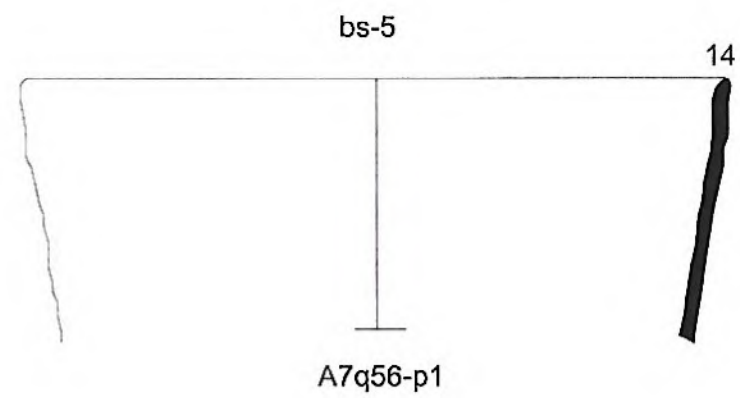
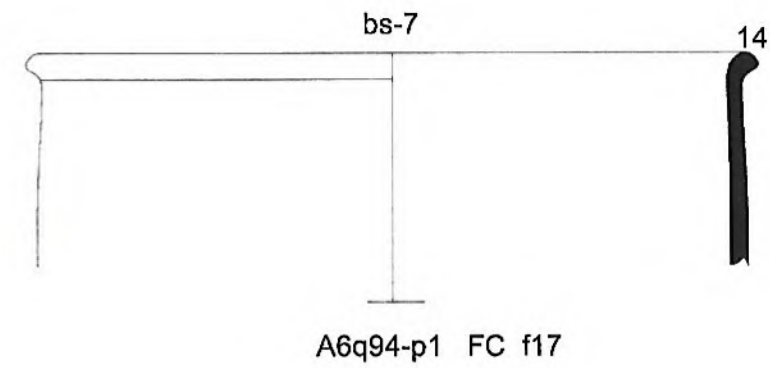
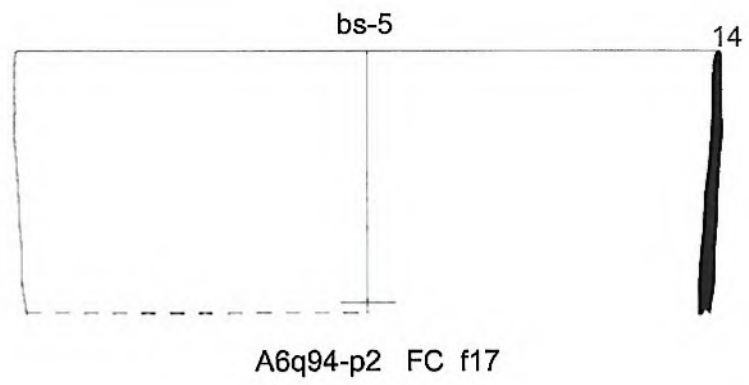
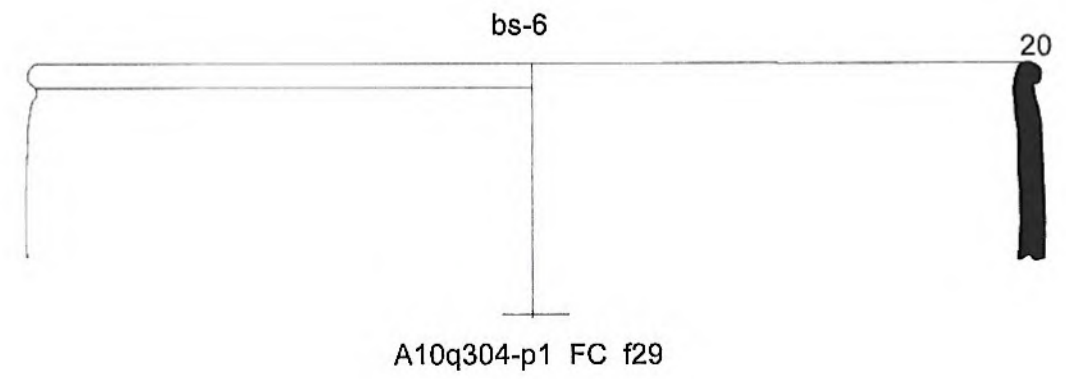
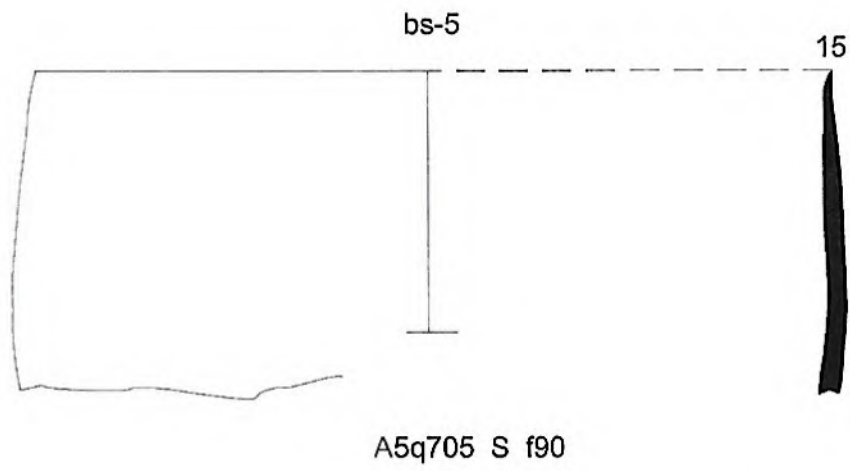
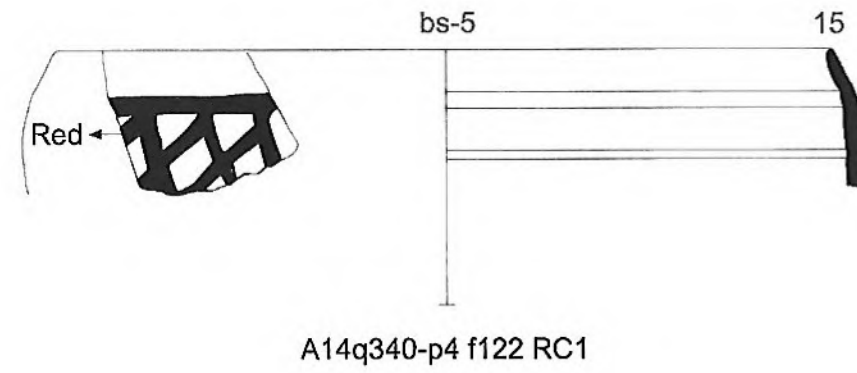
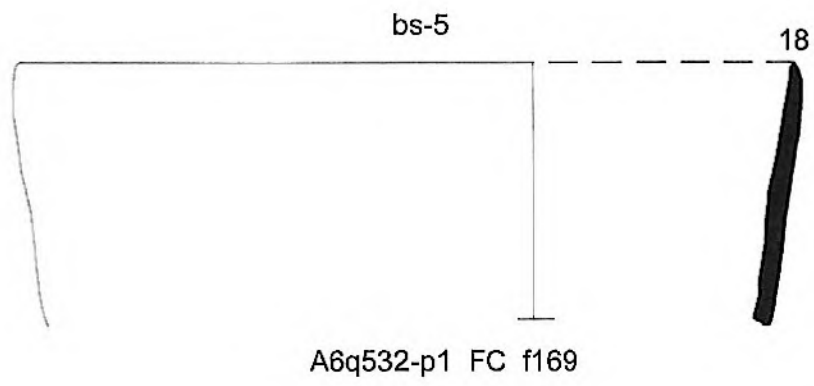

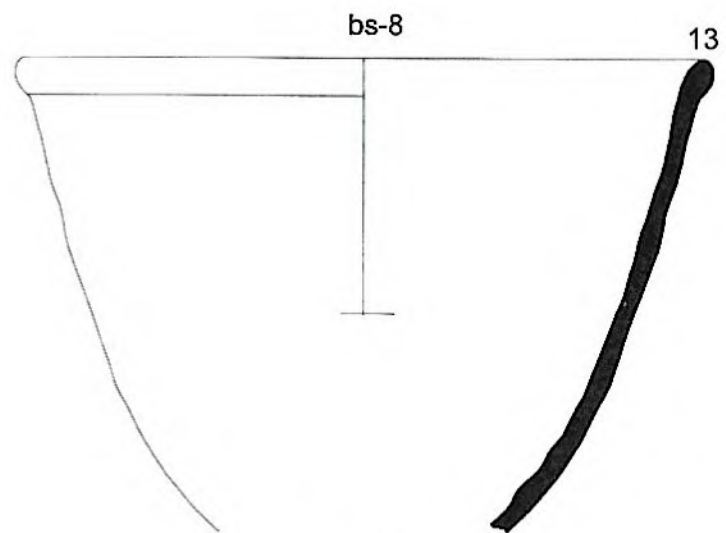

A2.5 M

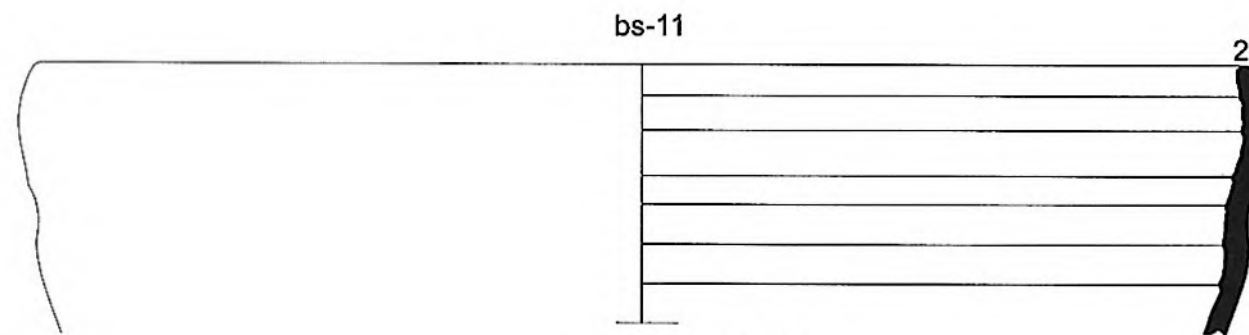

A1q931-p S f113

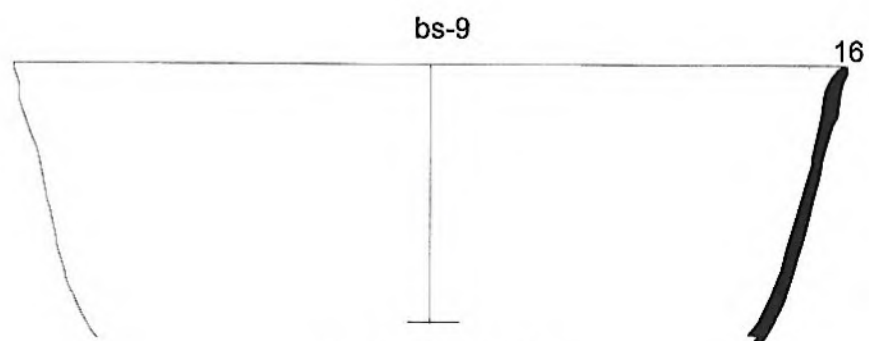

A8q139-p1 FC f43

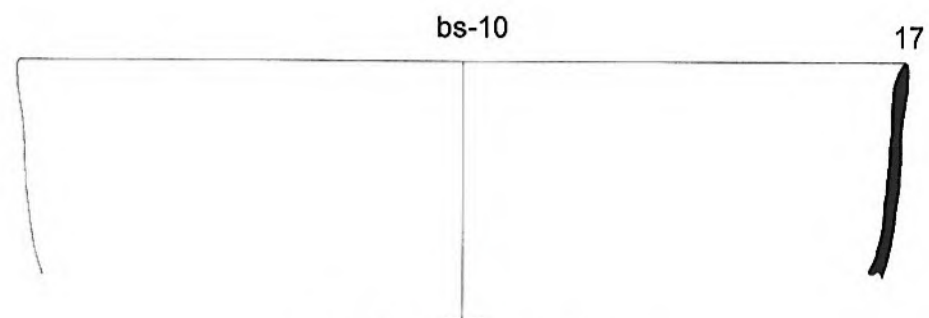
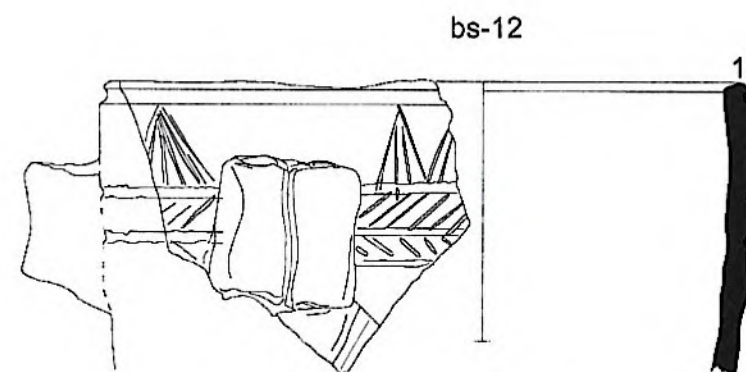

A10q182-p1 S f197

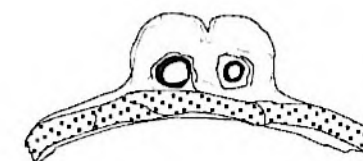

A14q424-p1 f176

Carinated bowls - With Rounded Carination

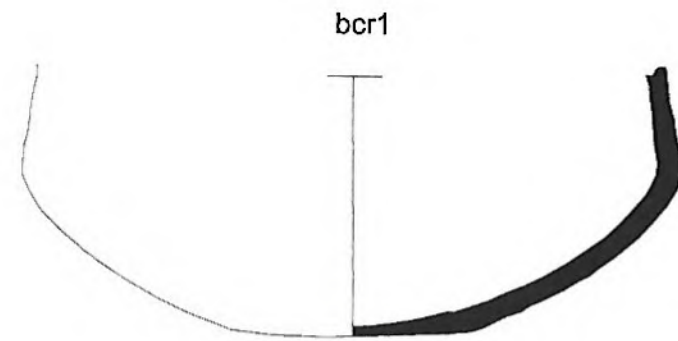

A10.61 ROG f116

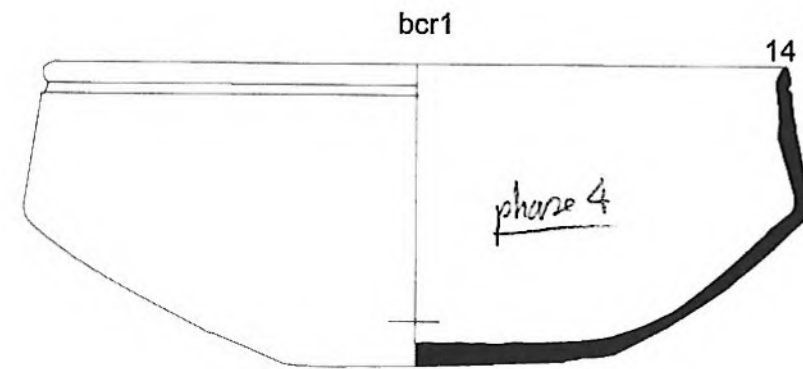

A10.26 FC

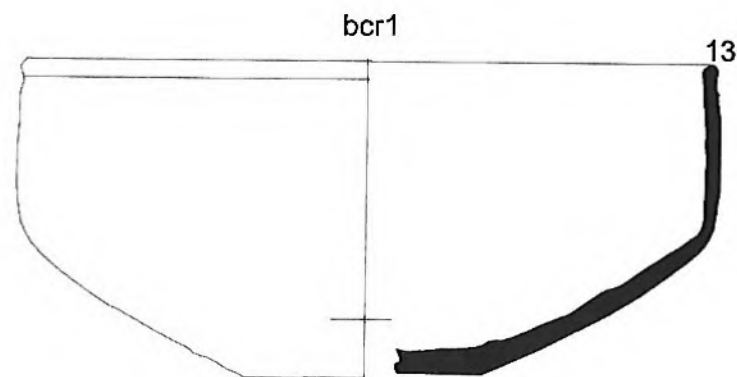

A10q188-p1 FC f102

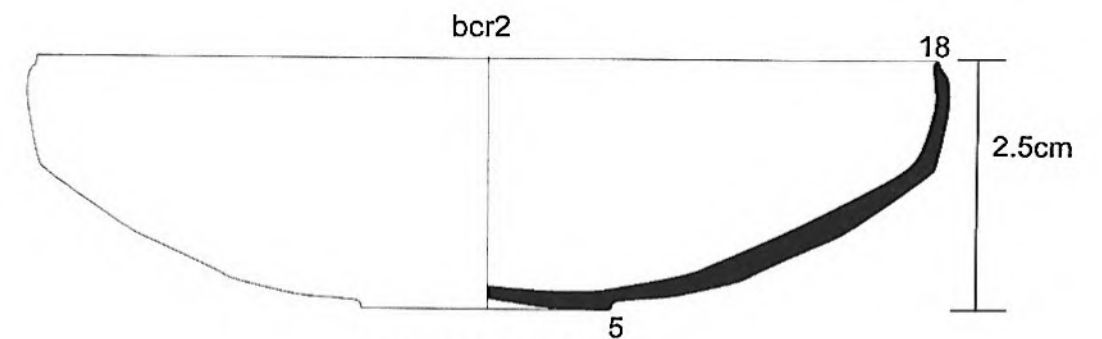

A7q418-p2 FC f82

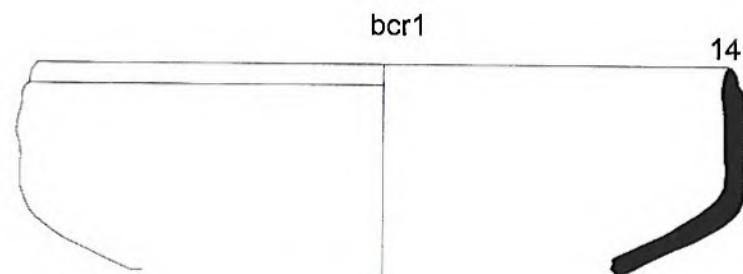

A7q401-p1 FC f136

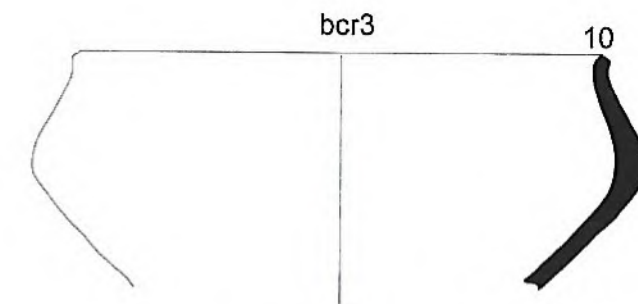

A10q165-p1 ROG f97

Carinated bowls - With Rounded Carination

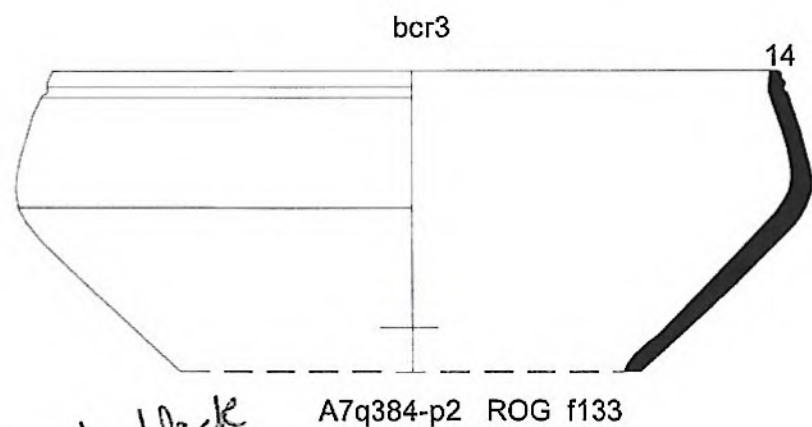

why black
↓

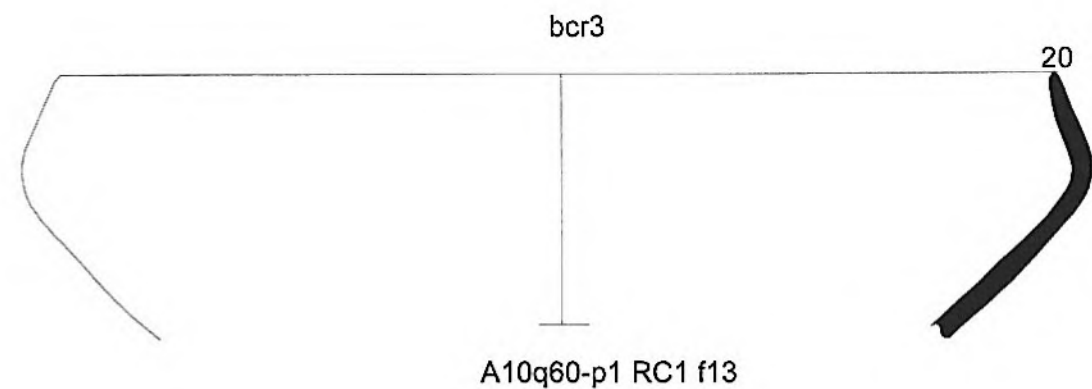
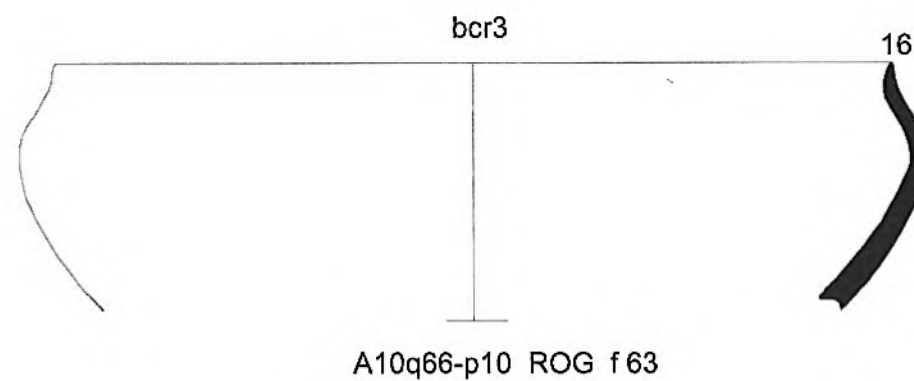
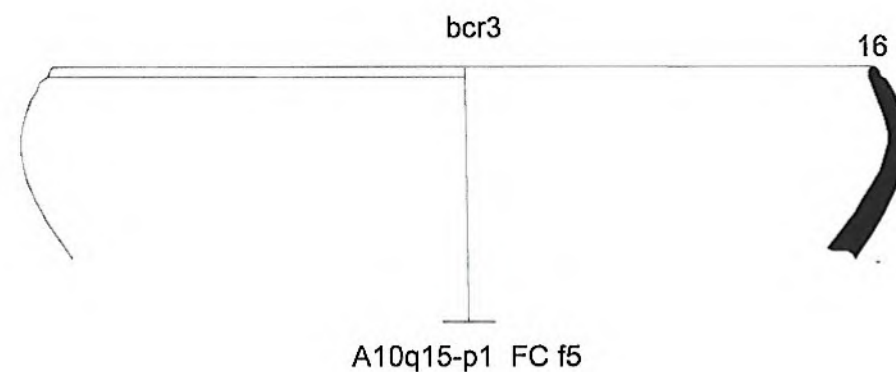
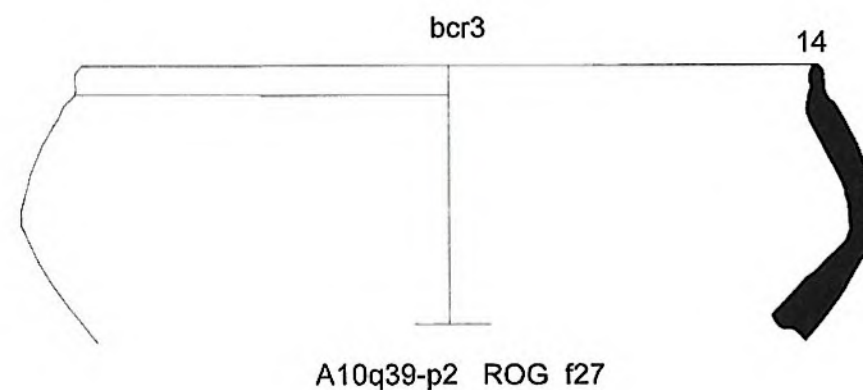
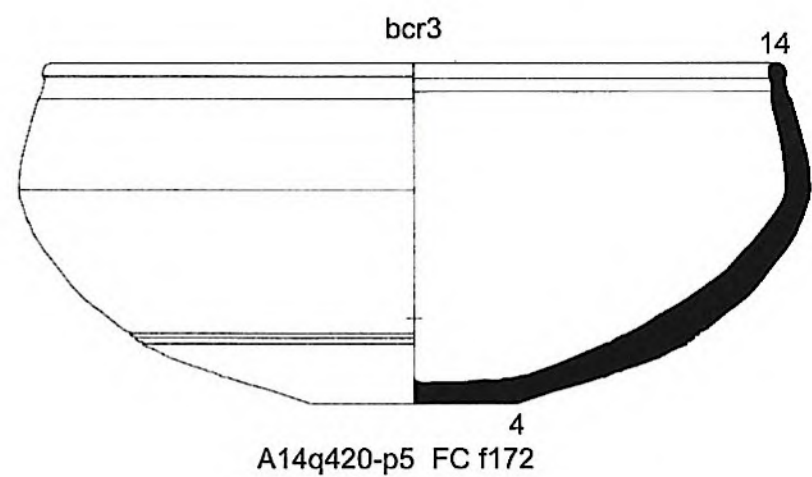
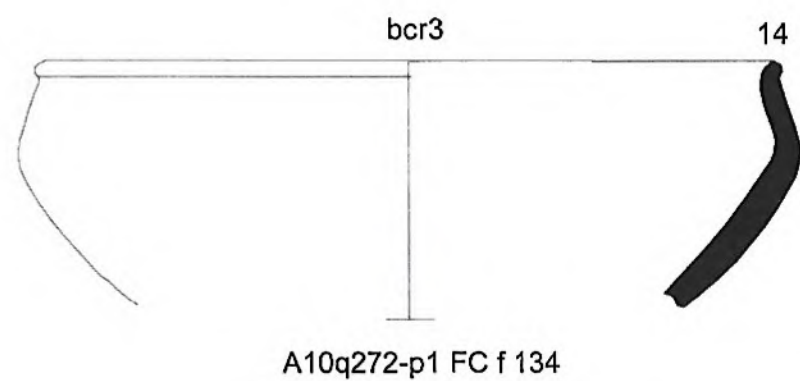
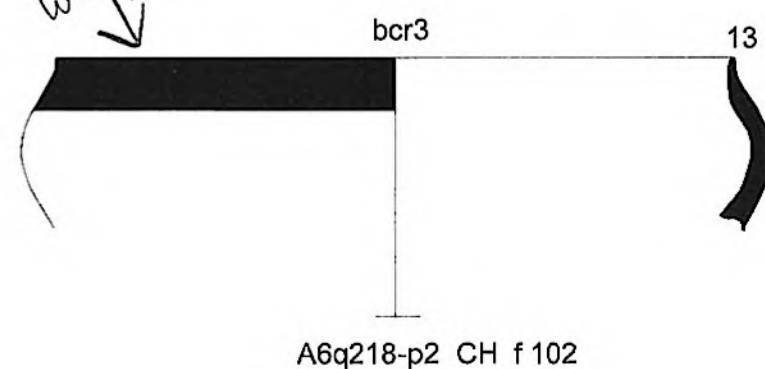

*Notched
Muss*

Carinated bowls - With Rounded Carination

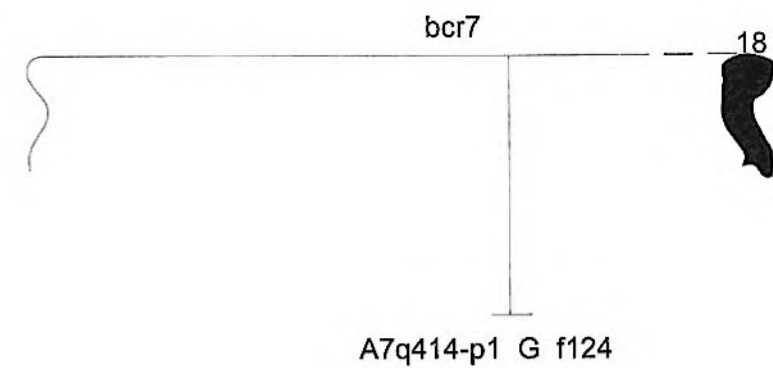
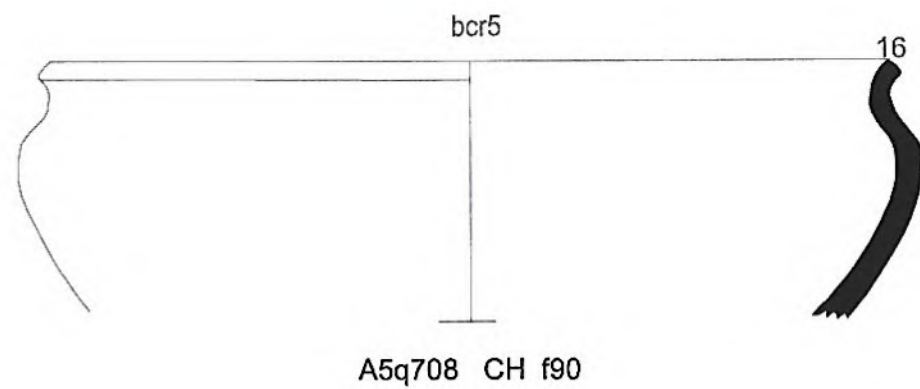
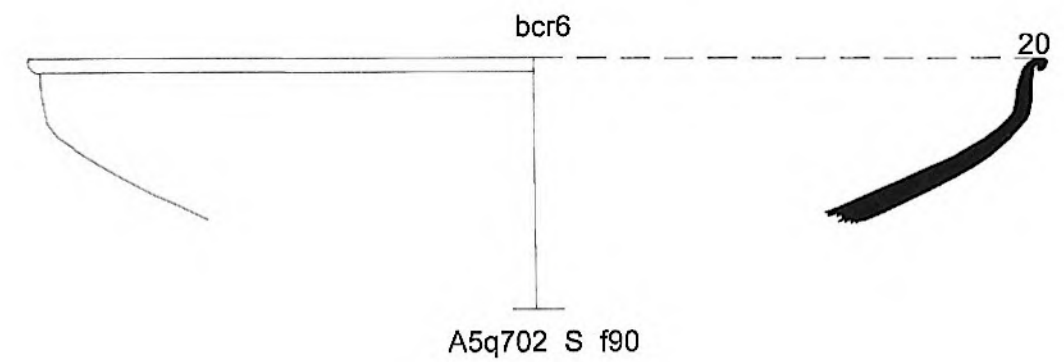
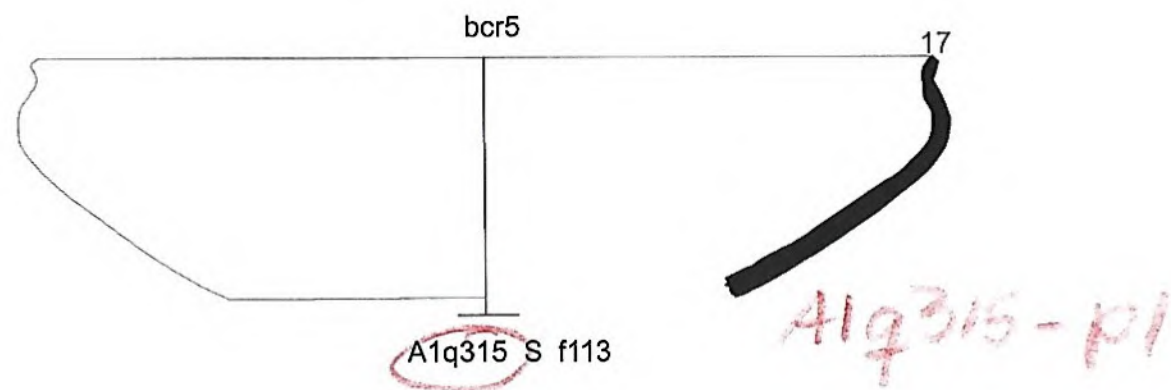
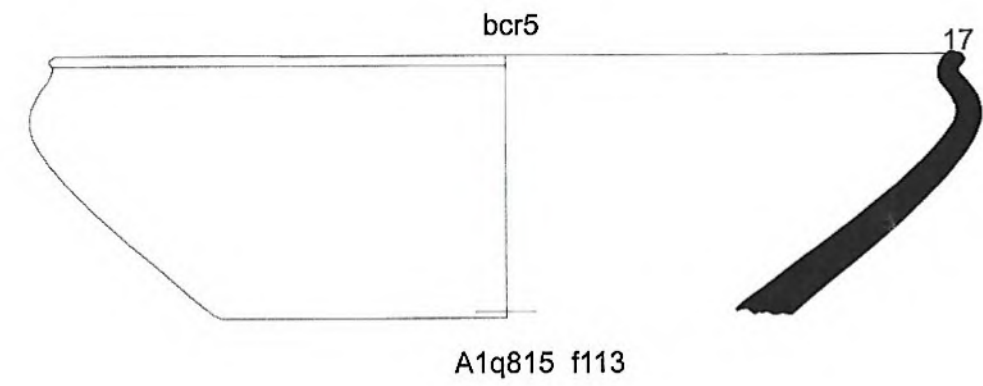
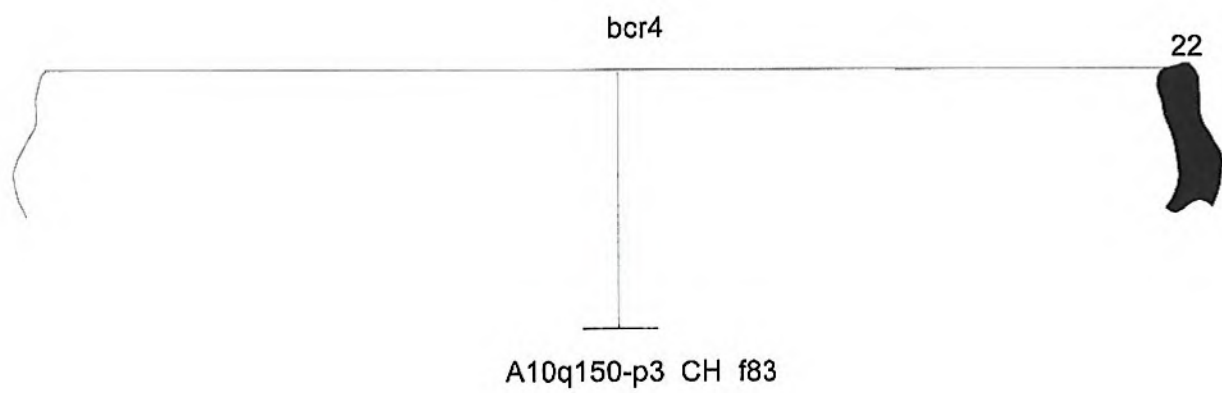
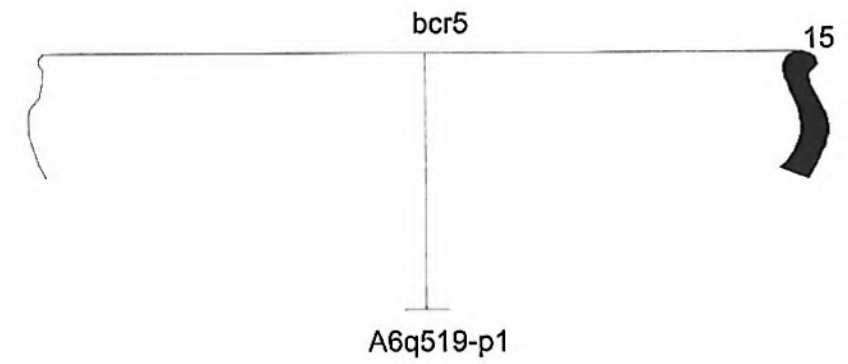
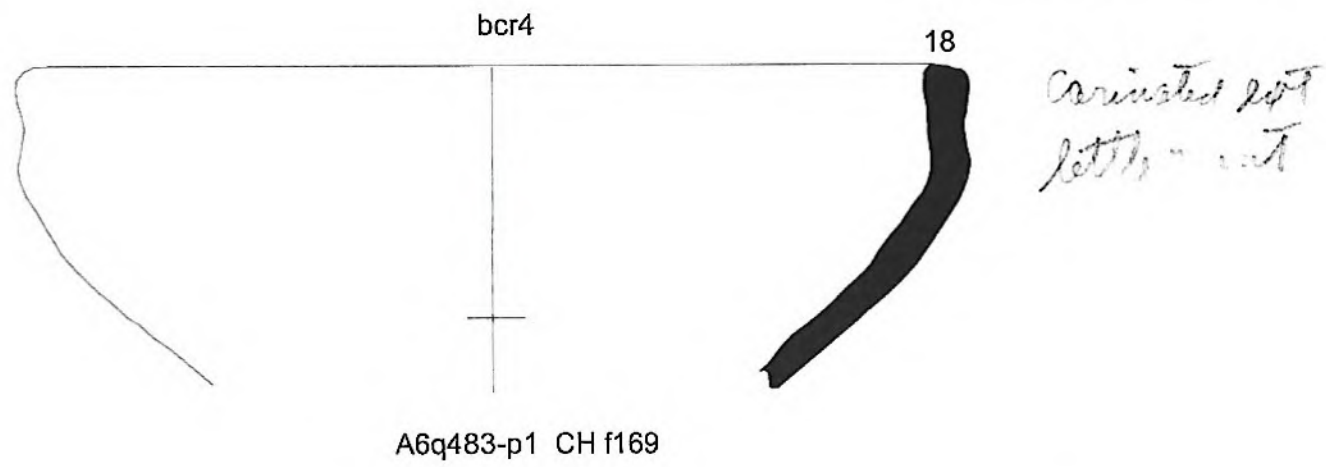

Carinated Bowls - With Sharp Carination

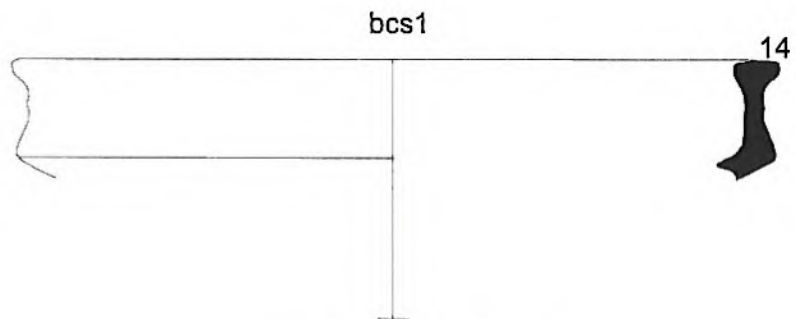

A10q203-p6 FC f110

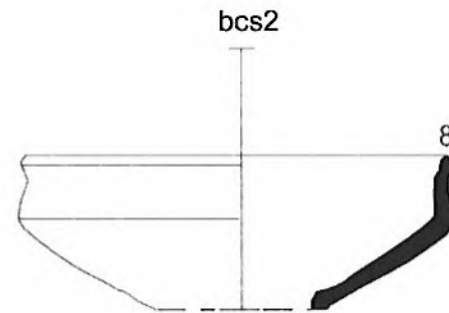

A7q384-p3 G f133

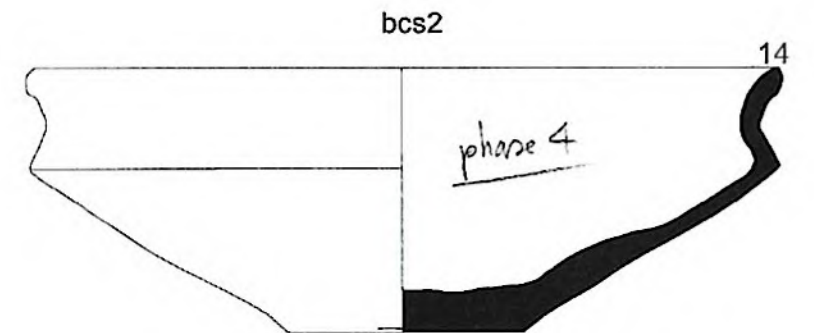

A10.84 FC f133

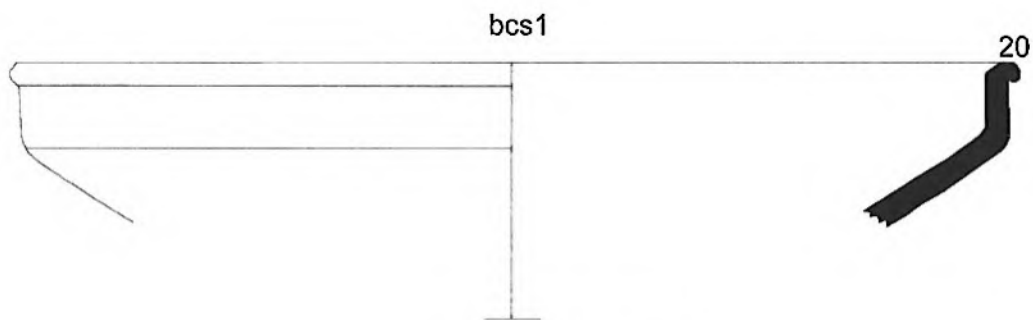

A1q901-p FC f113

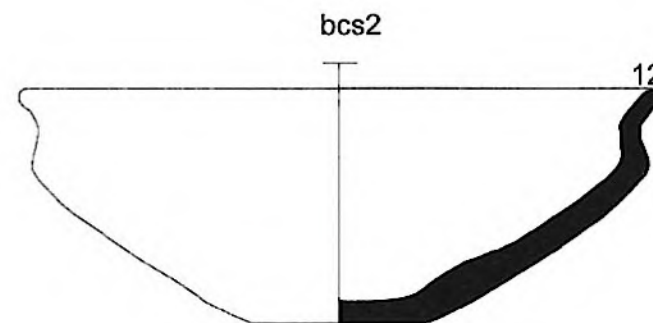

A7.203 ROG f149

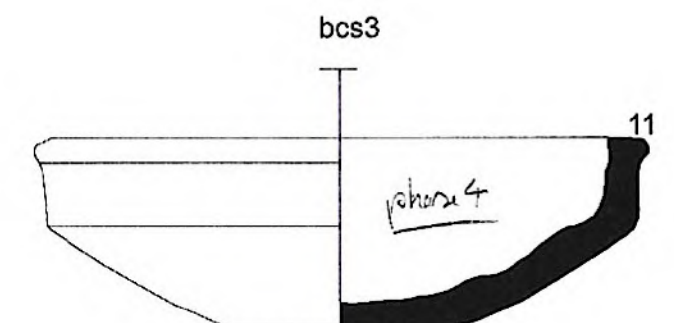

A2.106 ROG f106

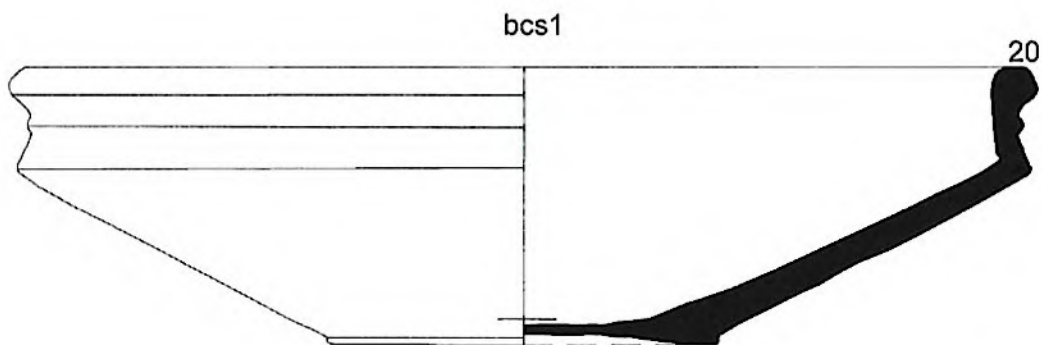

A6q825-p1 FC f345

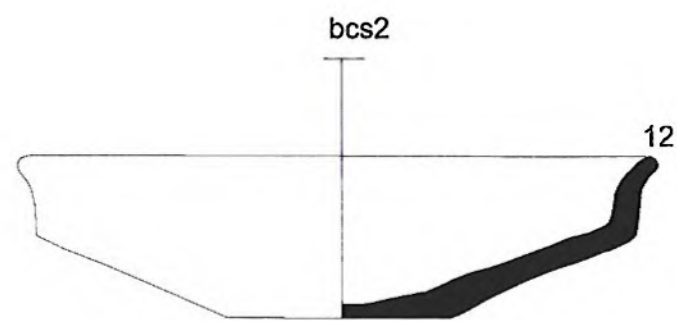

A7.78 CH f90

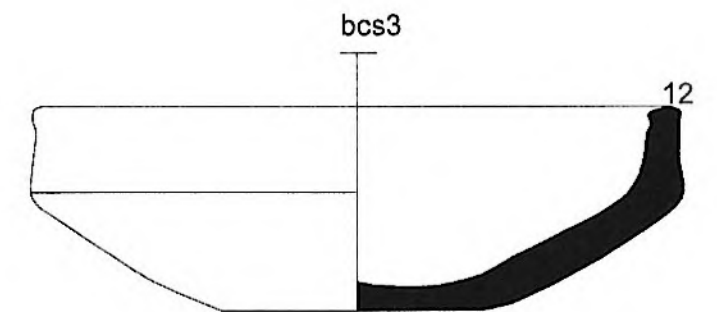

A7q724-p1 CH f188

Carinated Bowls - With Sharp Carination

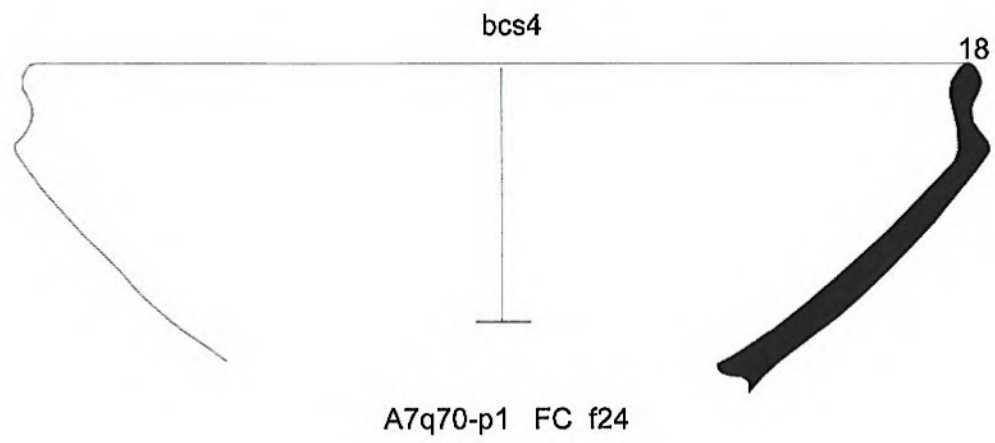
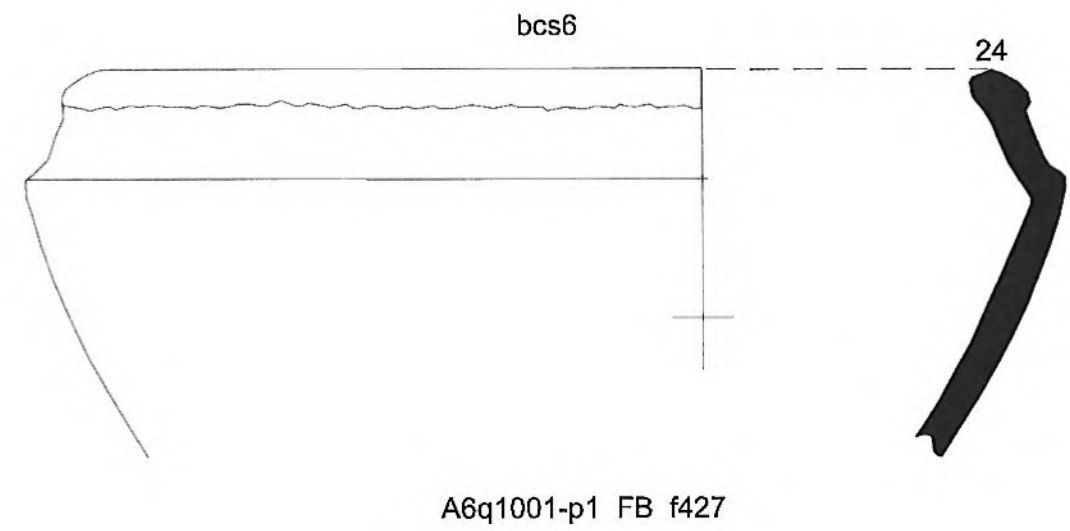
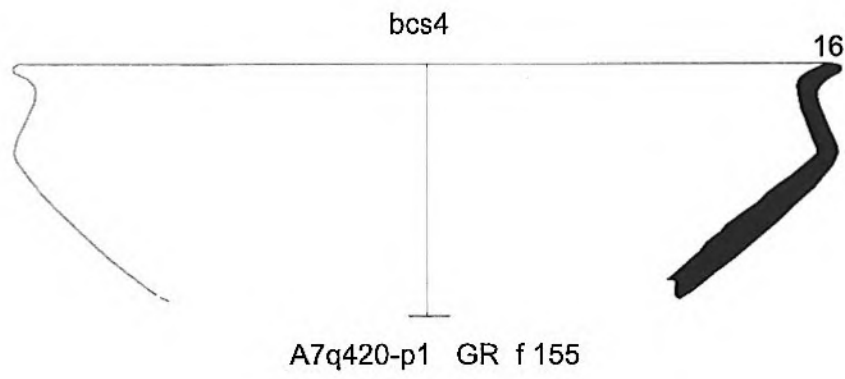
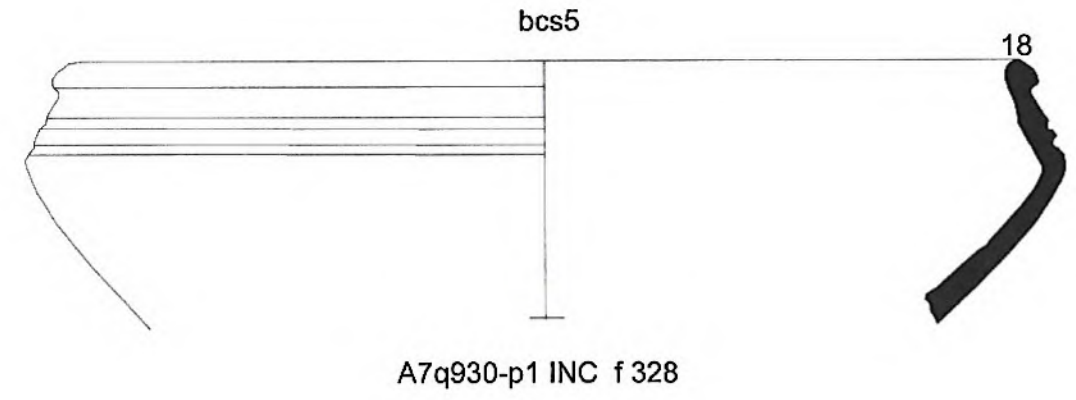
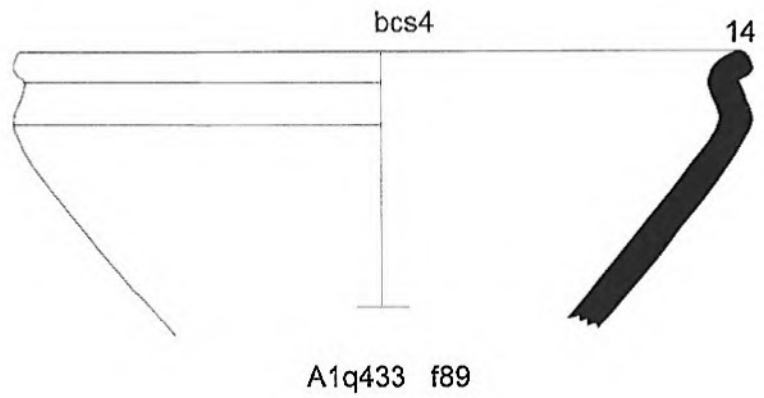

Carinated Bowls - With Sharp Carination

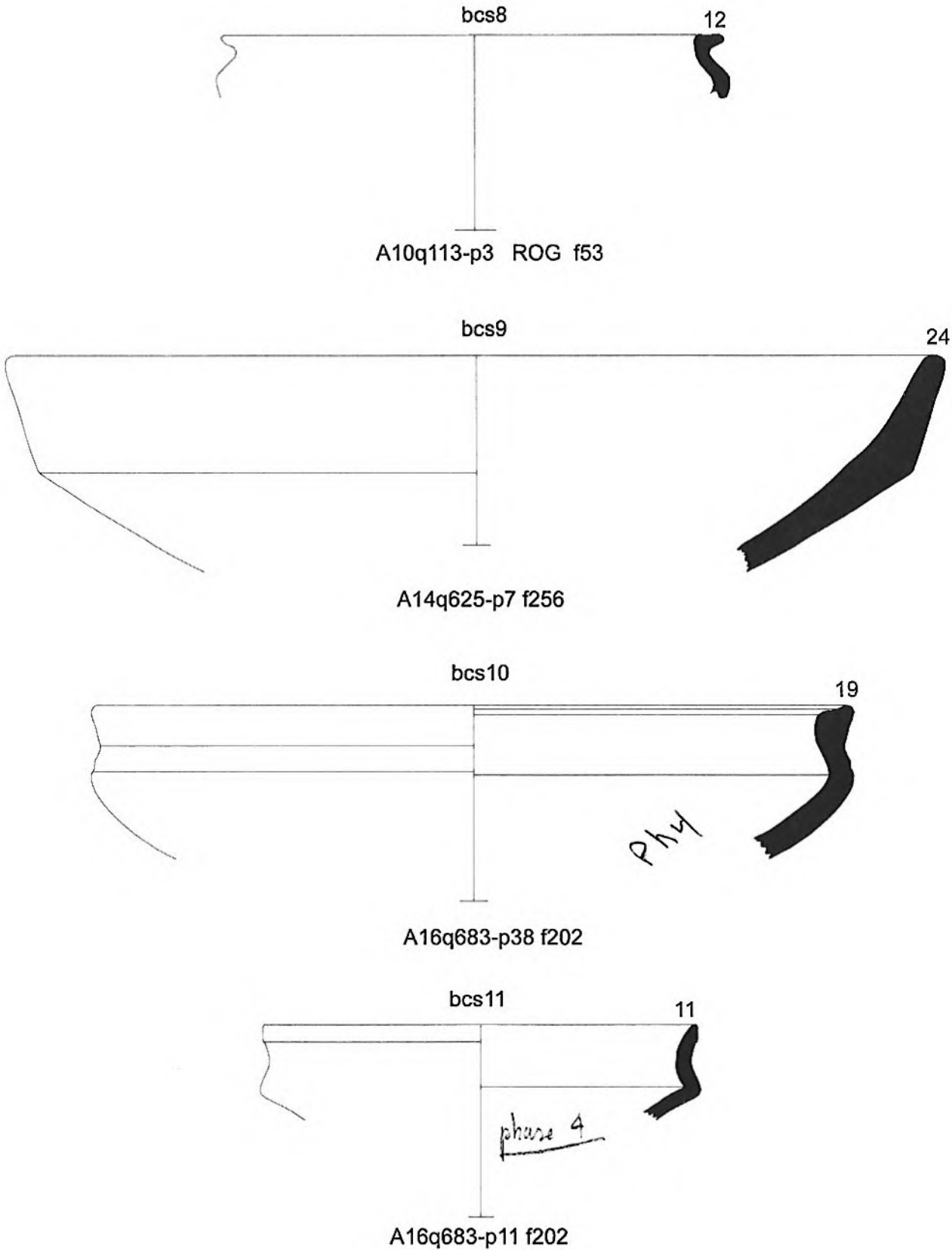

~~R715
 added bcs12
 get drawing from
 PH4 cat.
 bcs13 - in PH4 cat,
 bcs14
 bcs15~~

Deep Bowls

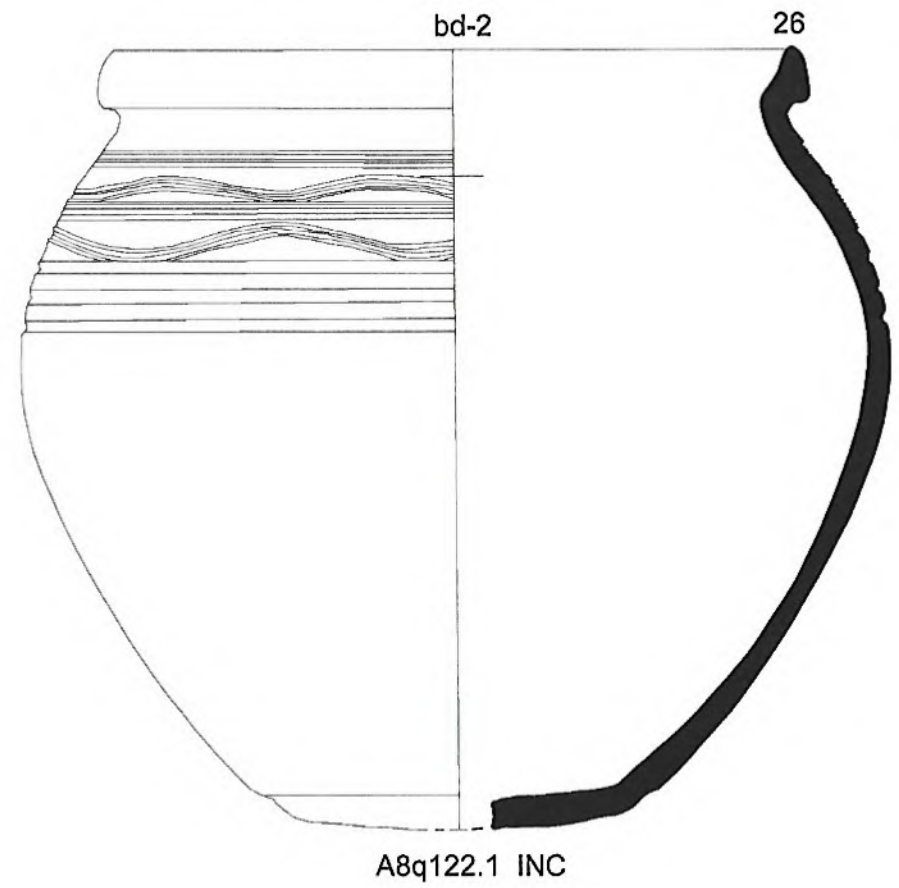
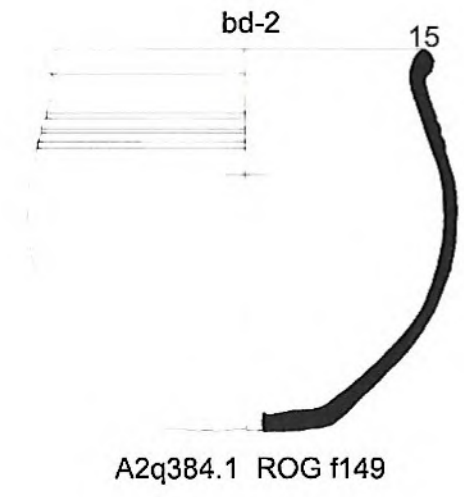
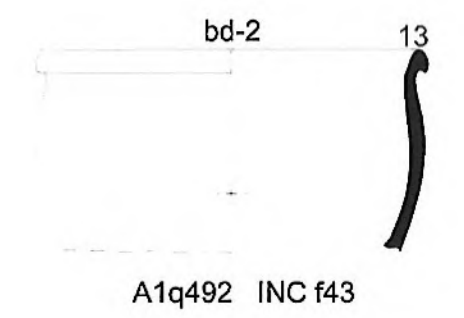
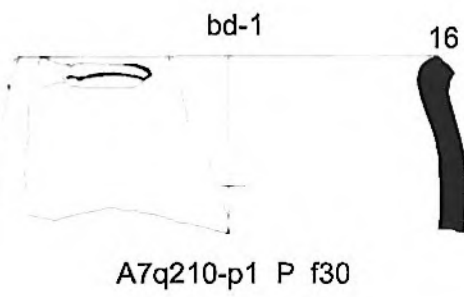
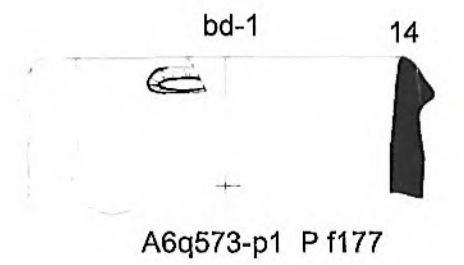
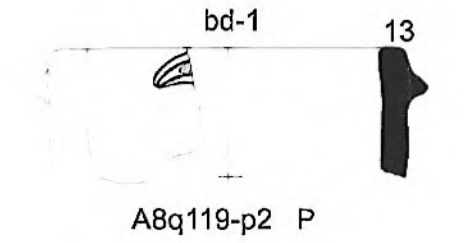

Deep Bowls

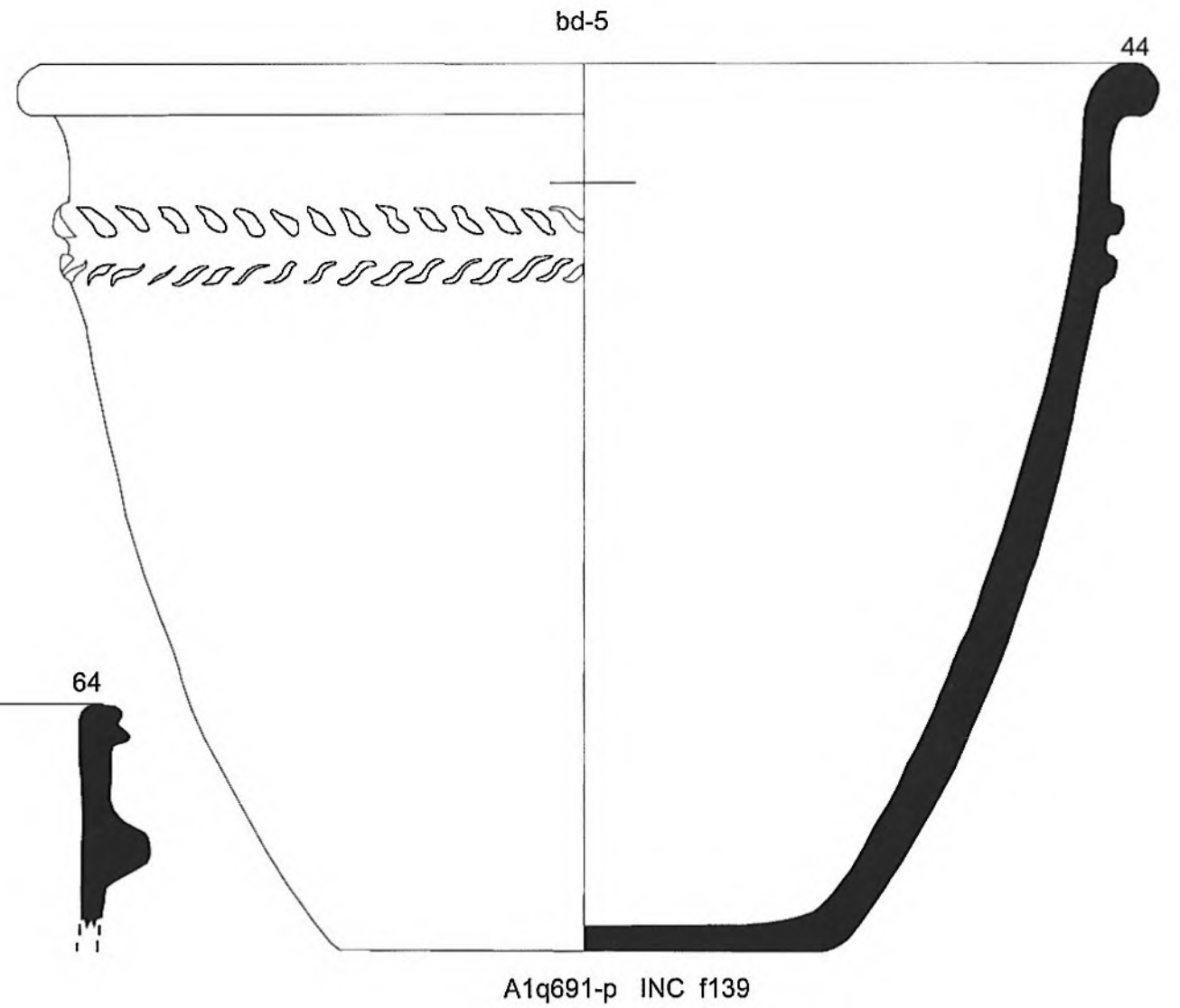
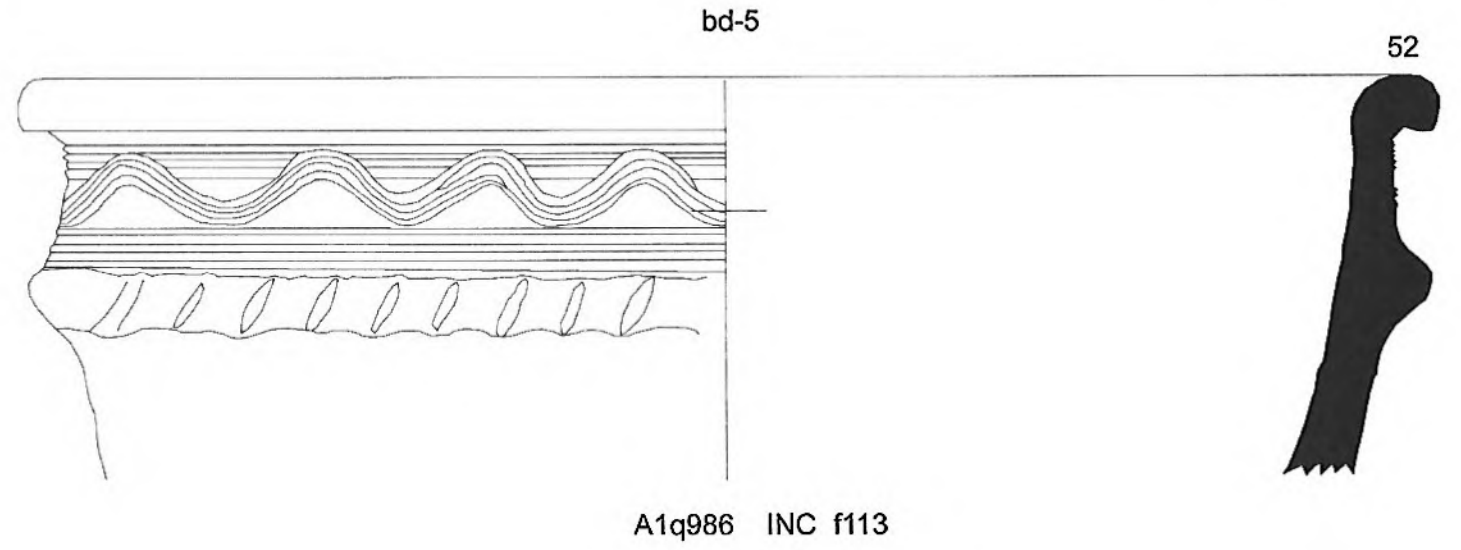
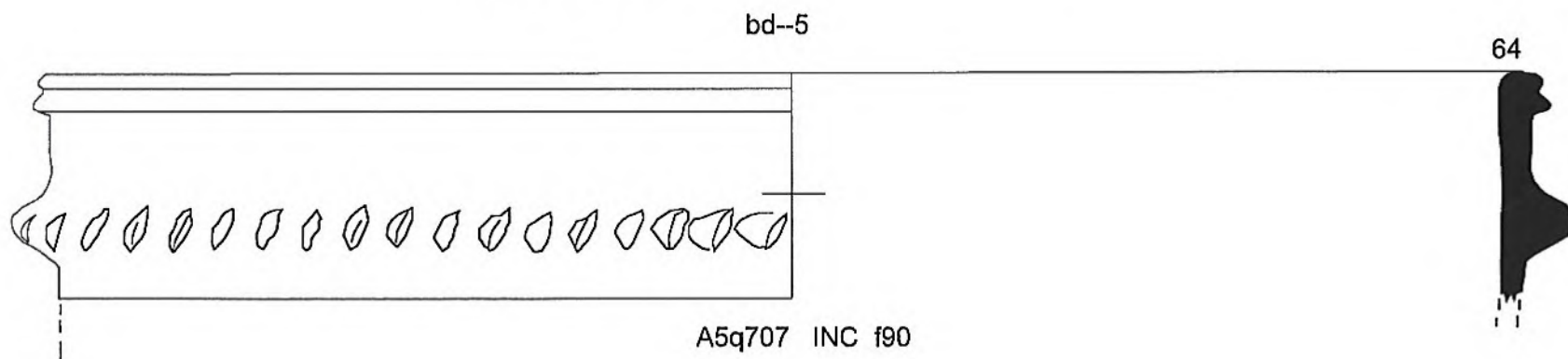
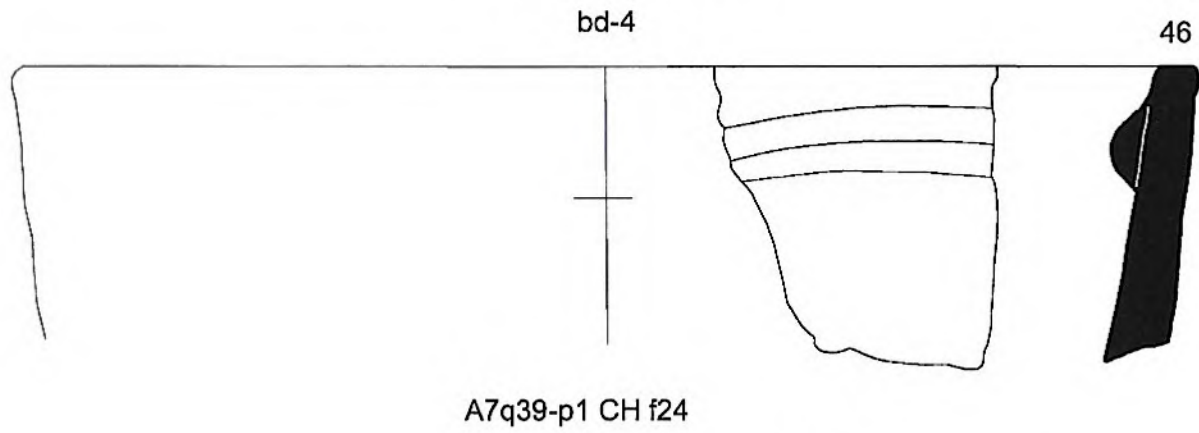
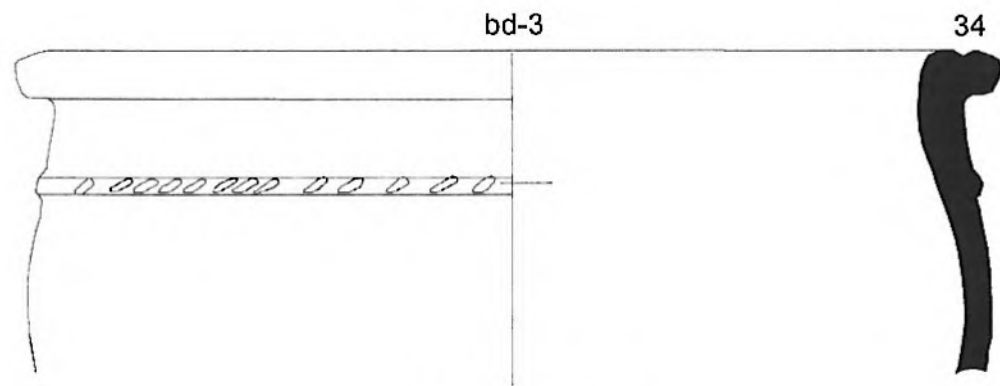
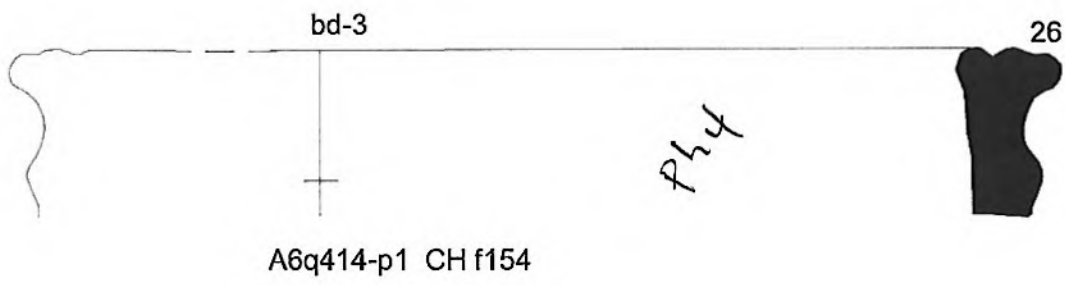

Deep Bowls

Milani

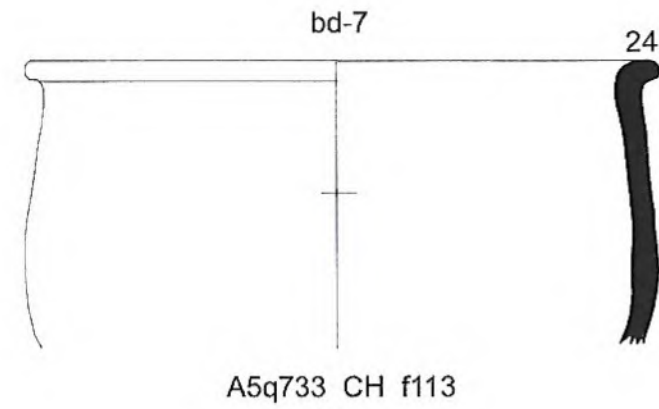
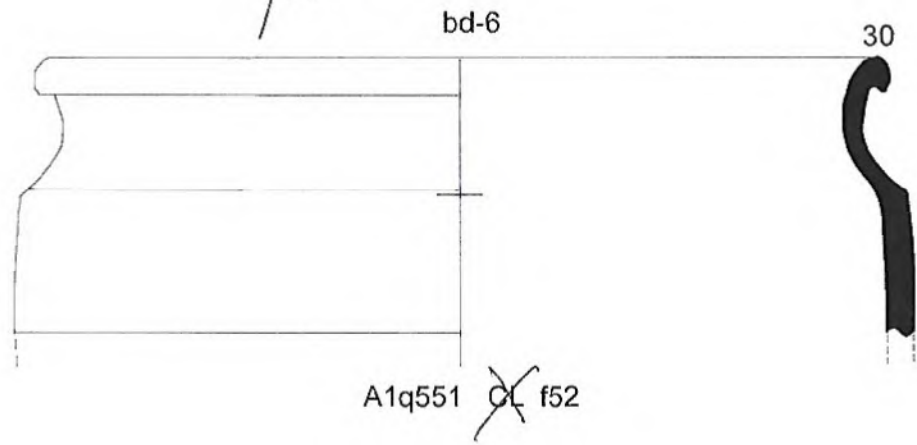

*Why here -
dec?*

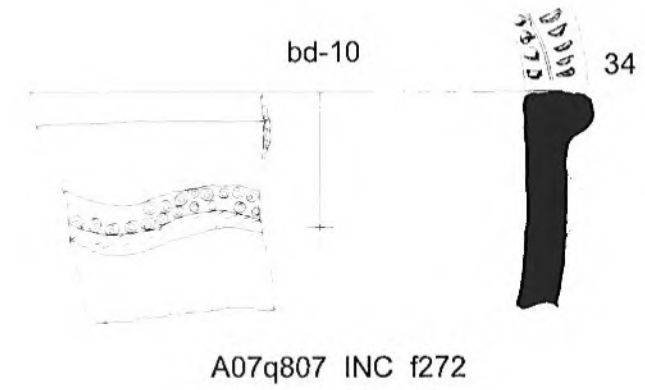
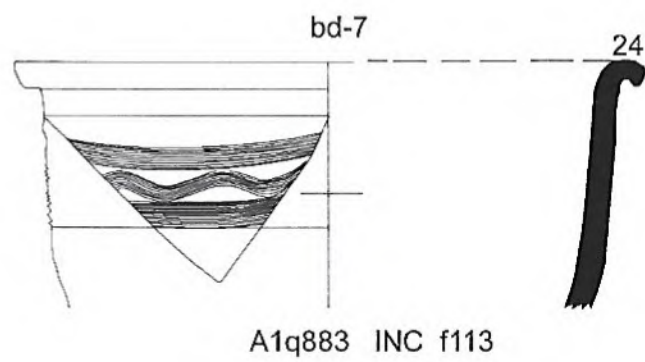
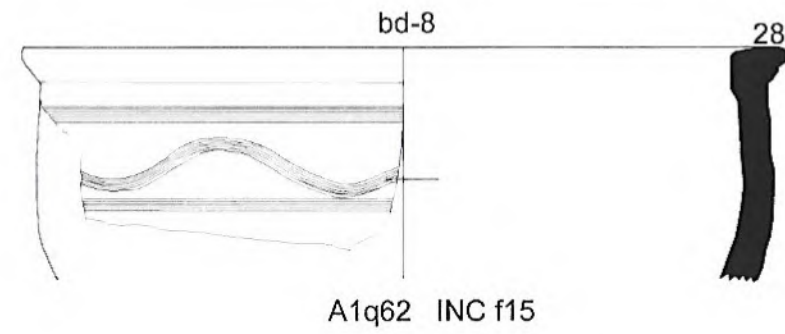
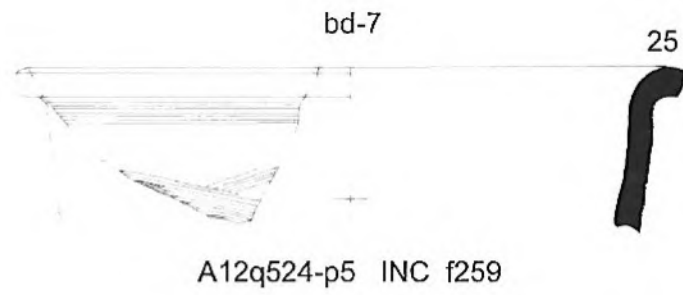

Deep Bowls

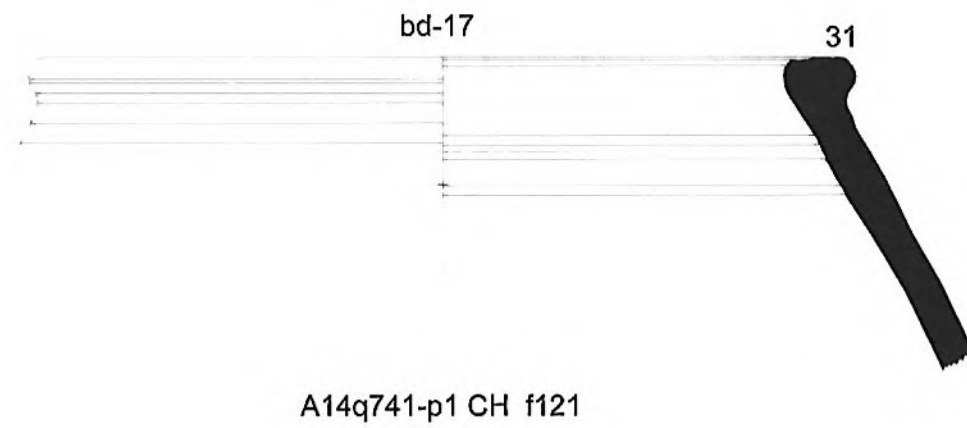
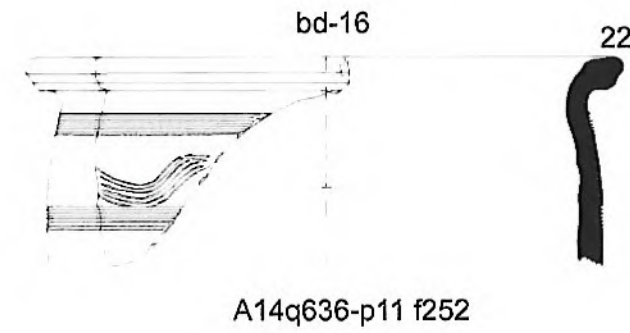
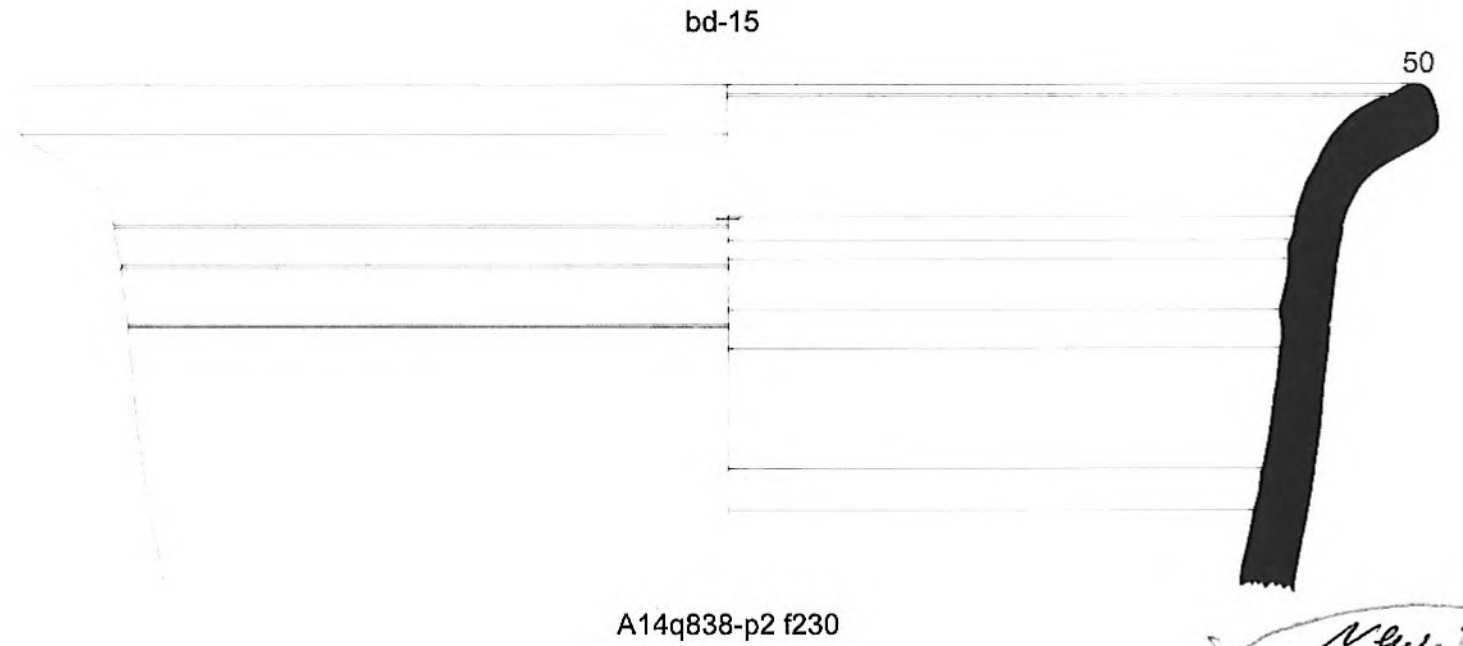
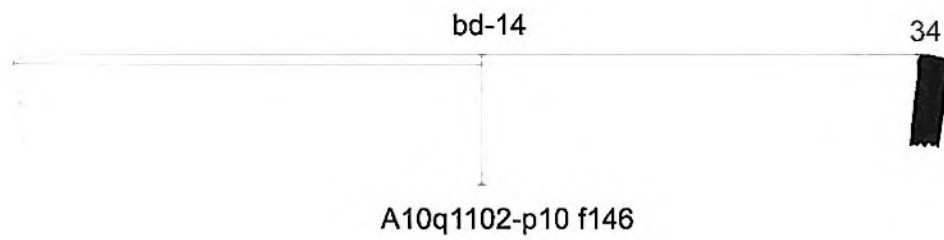
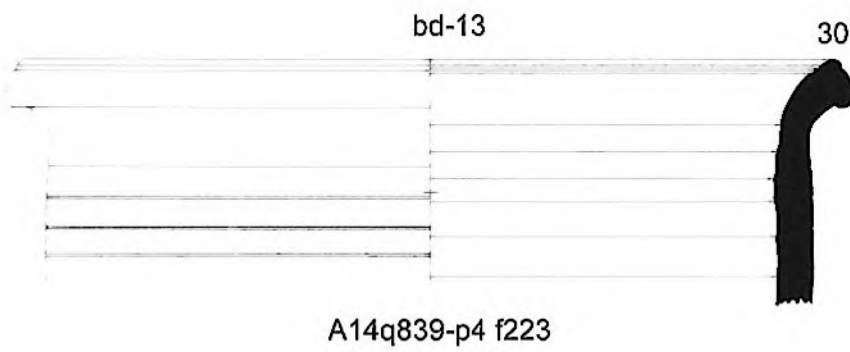
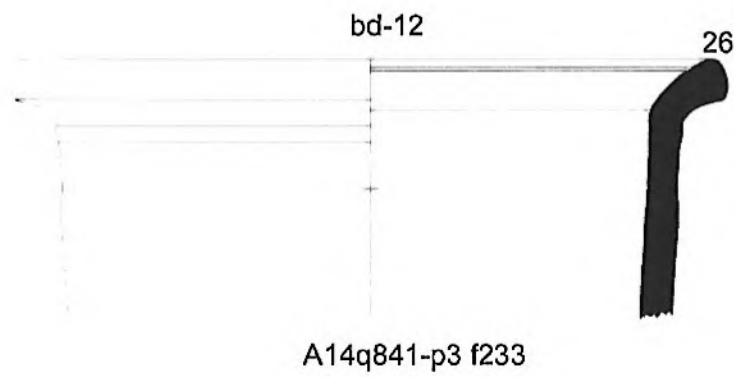
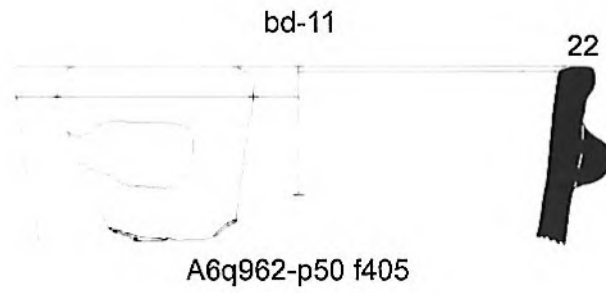

New in Phys cat.
R715
got from Phys cat
bd-20
" 21
" 22
" 23

Other Bowls



A5245 BR 1107



A82787 CH 108



A14241428 CH 1121

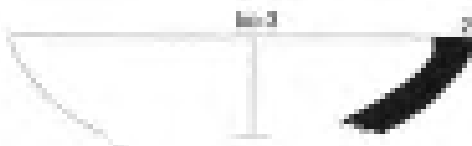

A82804 FC 110

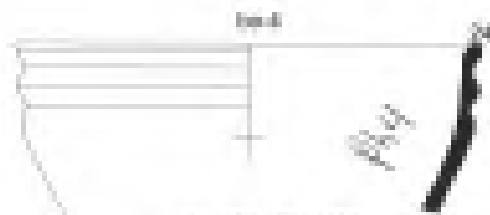

A14288 CH 1113

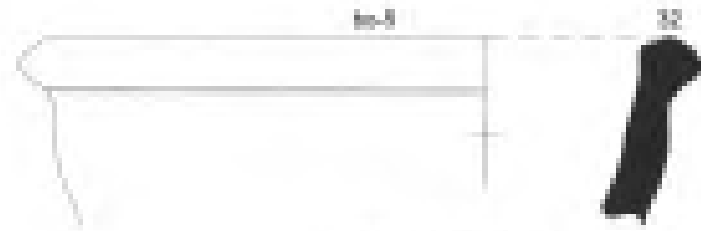

A1421428 CH 1124

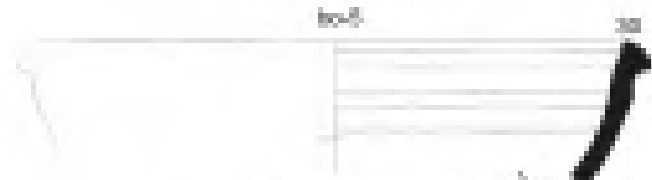

A821707 FC 116



A14229271 FC 1124

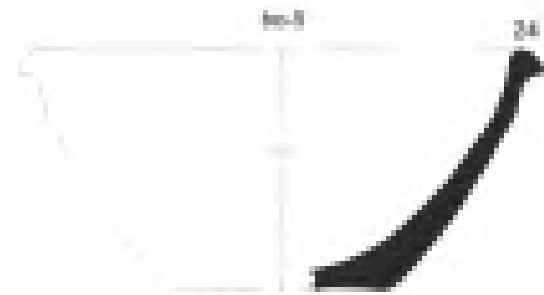

A8287445 CH 108

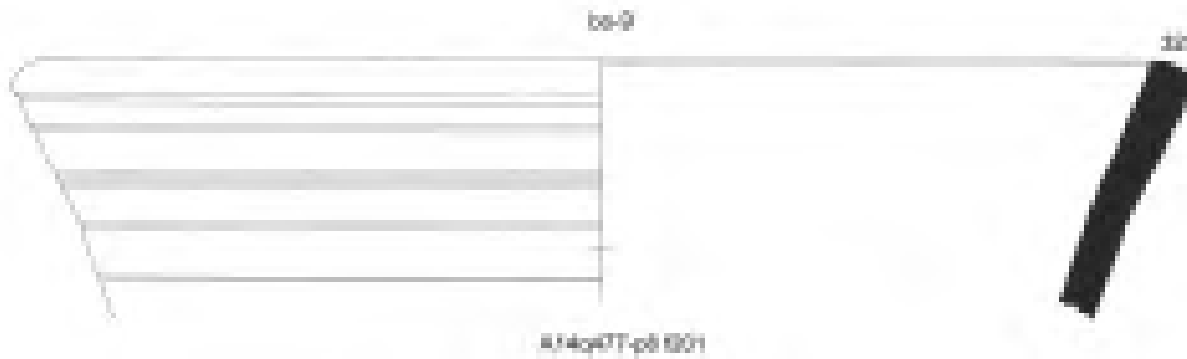
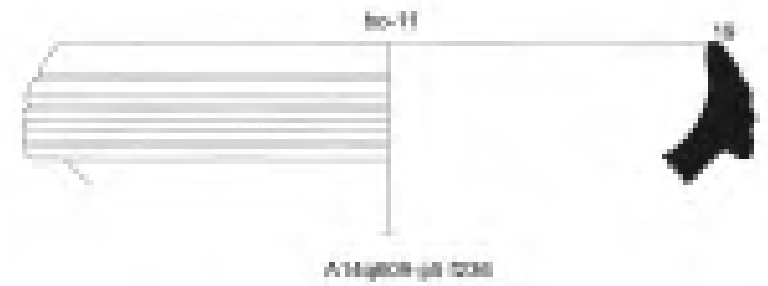
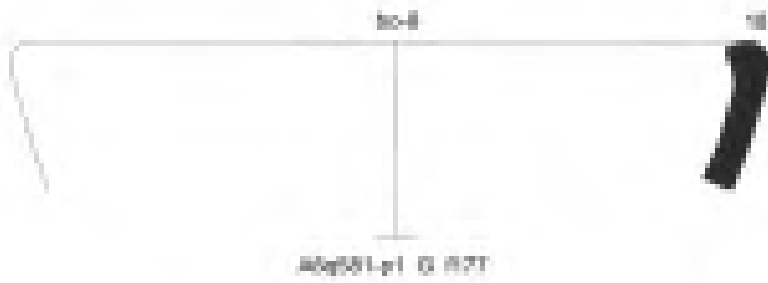

Platters-Plates

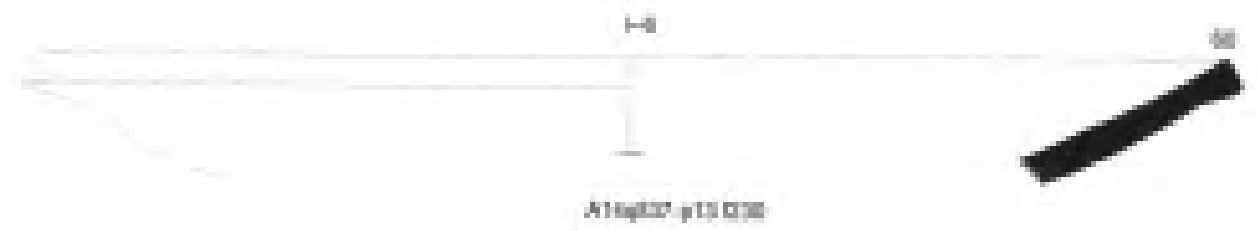
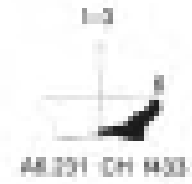
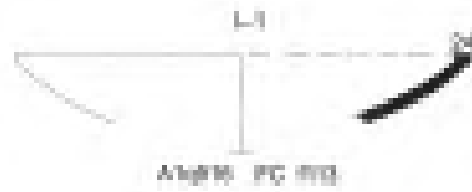

Stands

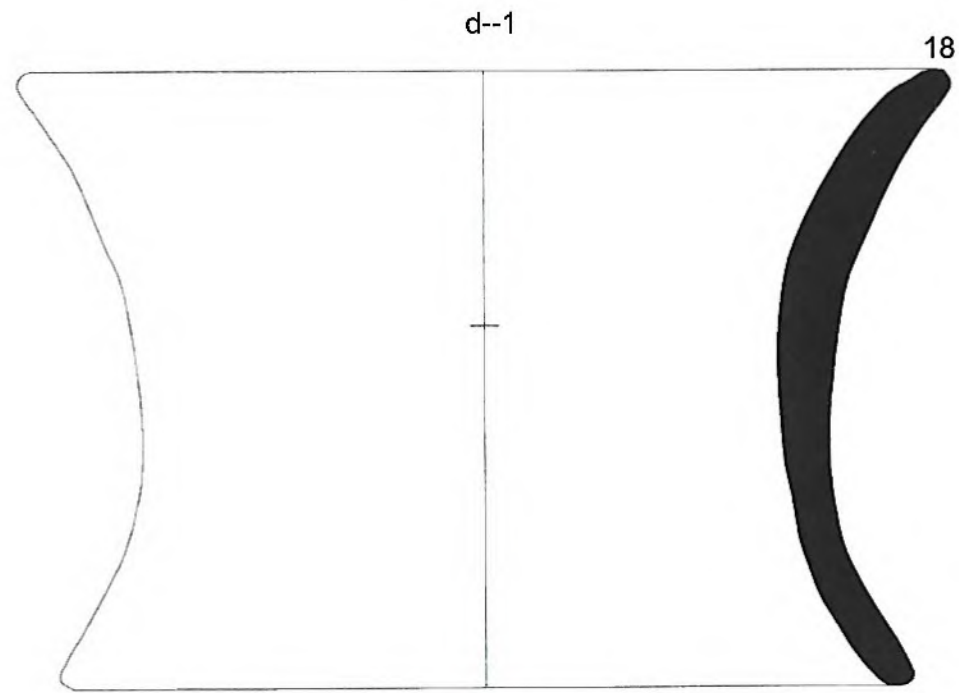

d--1

18

A10.110.1 CH f59

Jar or Stand

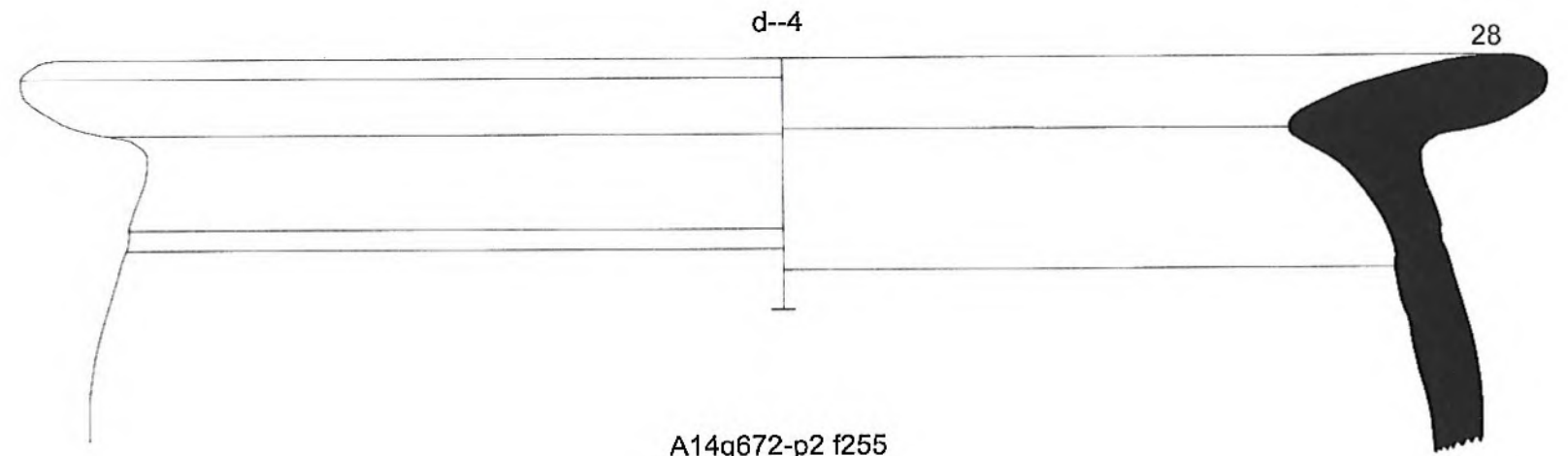

d--4

28

A14q672-p2 f255

d--2



8

A14q494-p3 f209

d--3

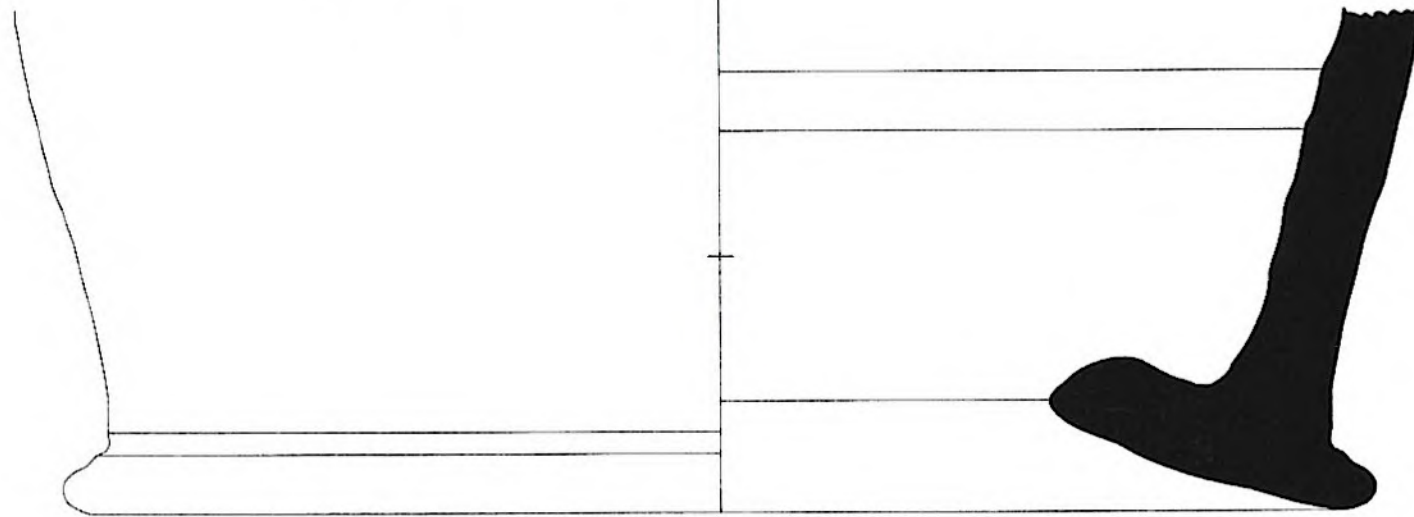

24

A14q567-p13 f237

Stand or Spout

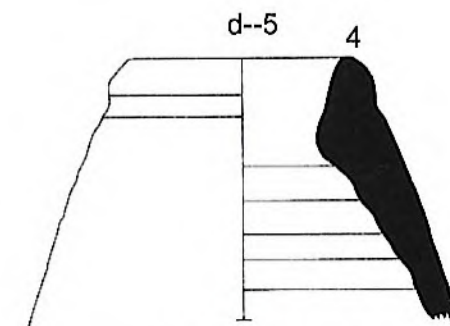

d--5

4

A14q447-p15 f186

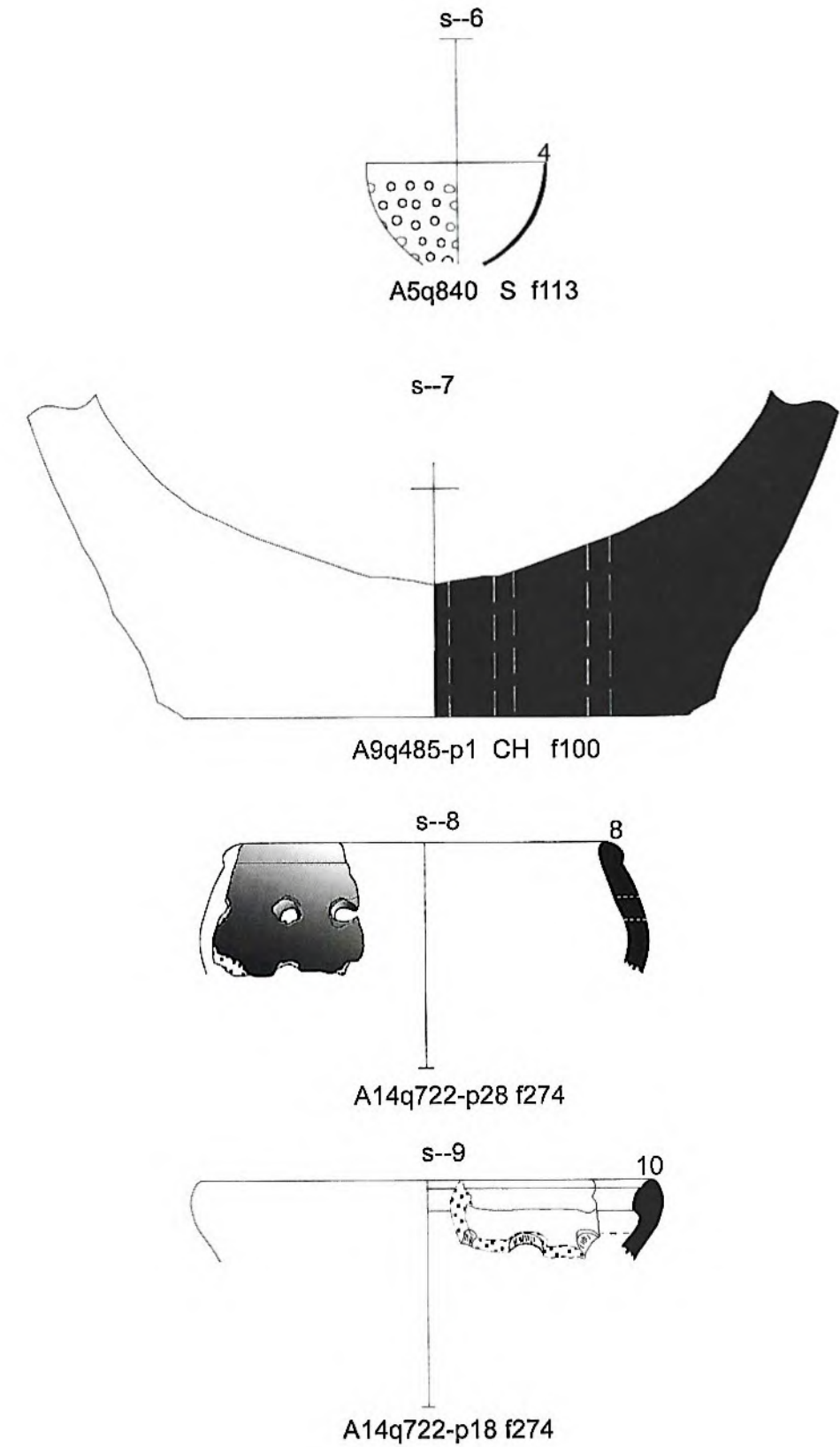
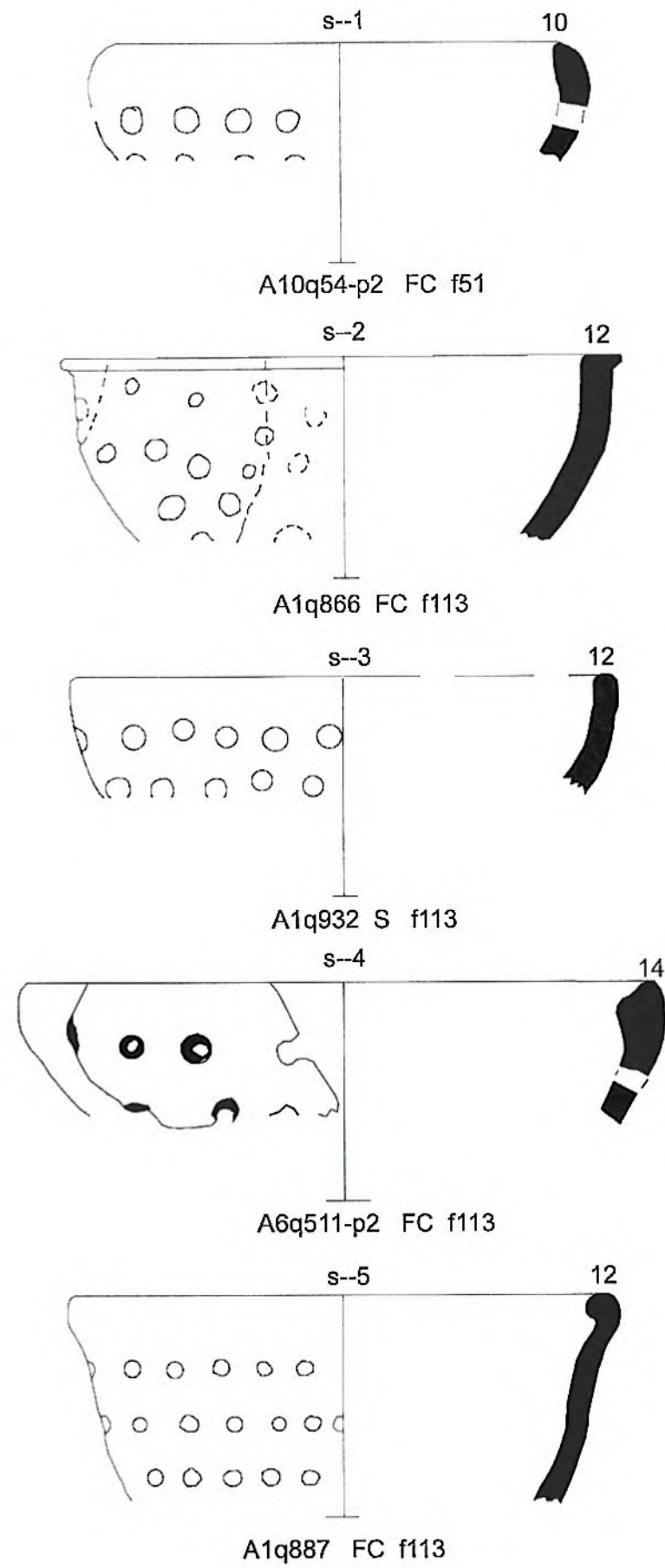

Flaring Neck Jars

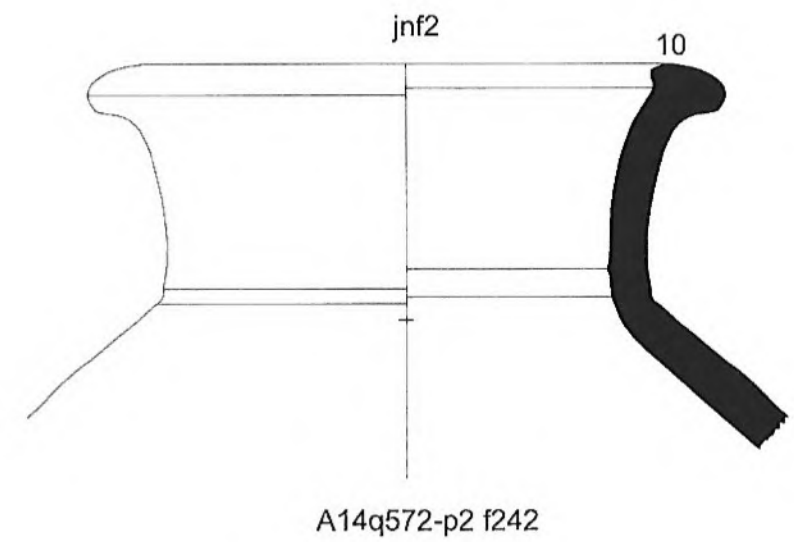
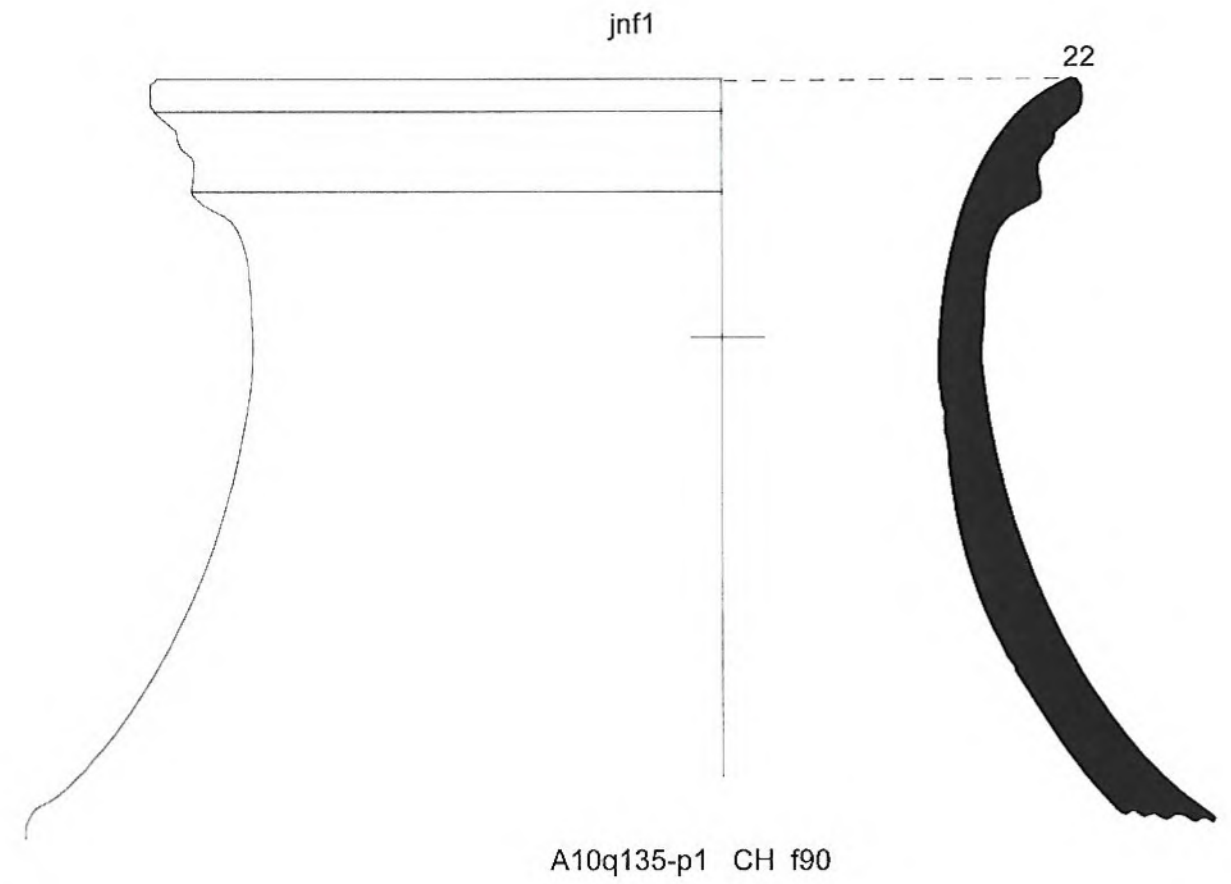
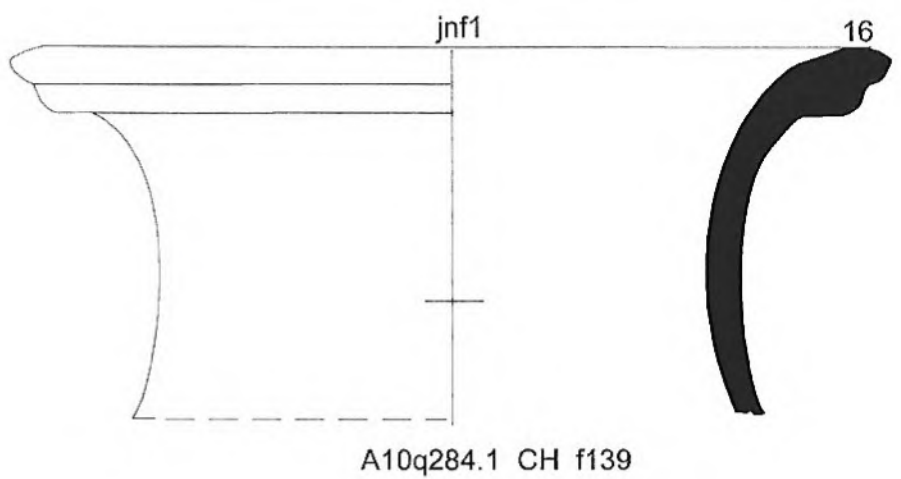
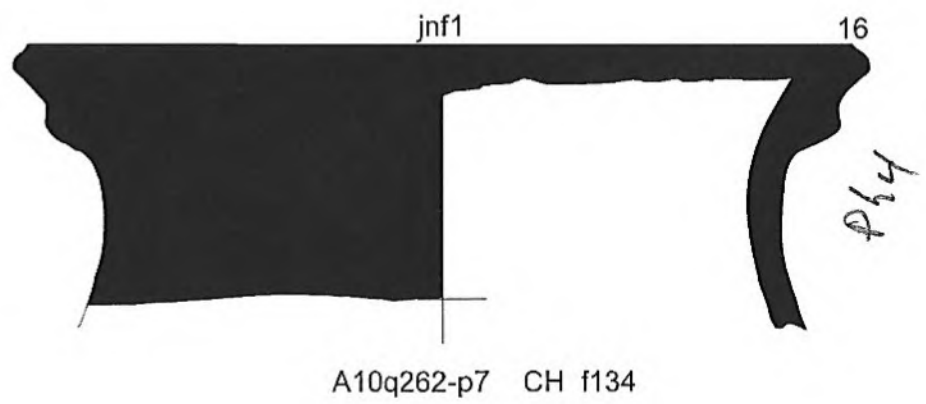
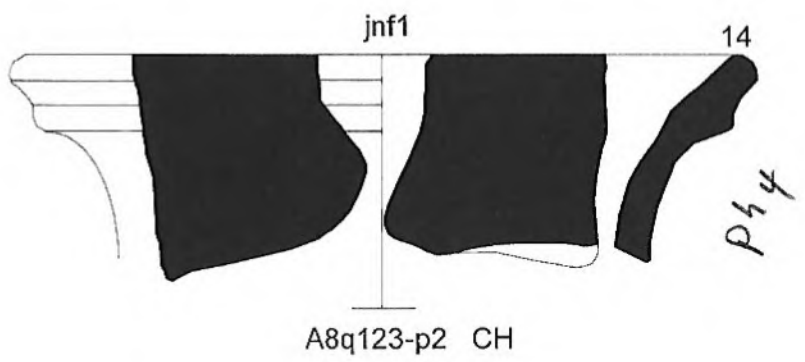
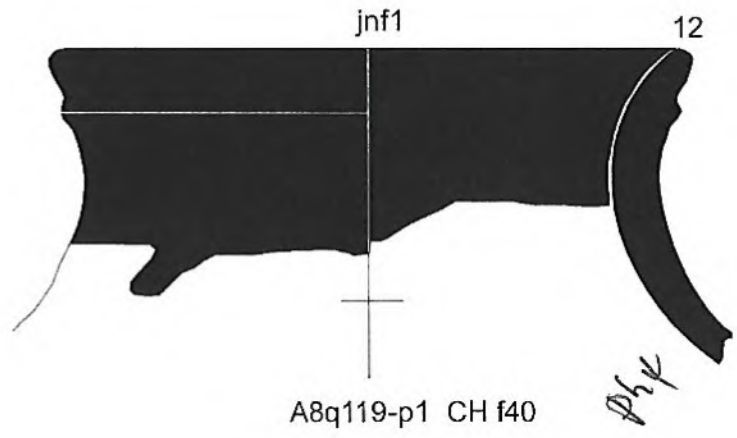

Flaring Neck Jars

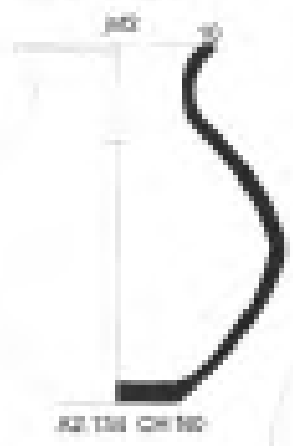
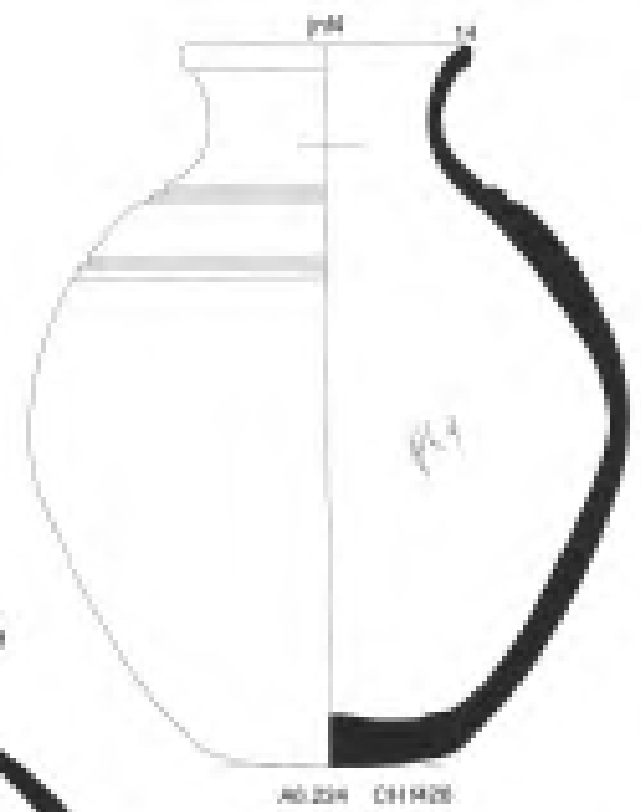
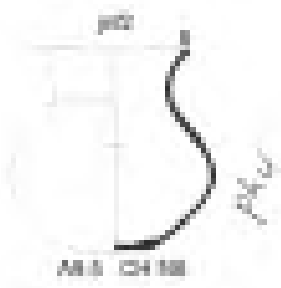

Flaring Neck Jars

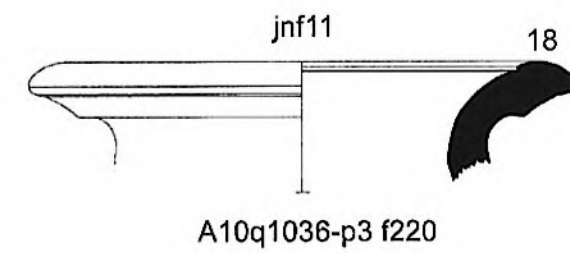
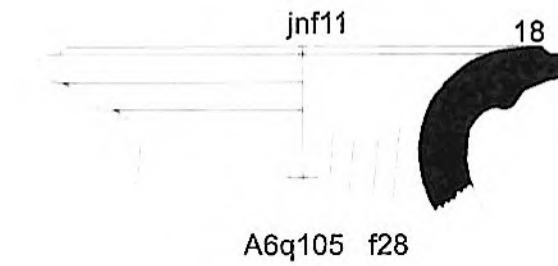
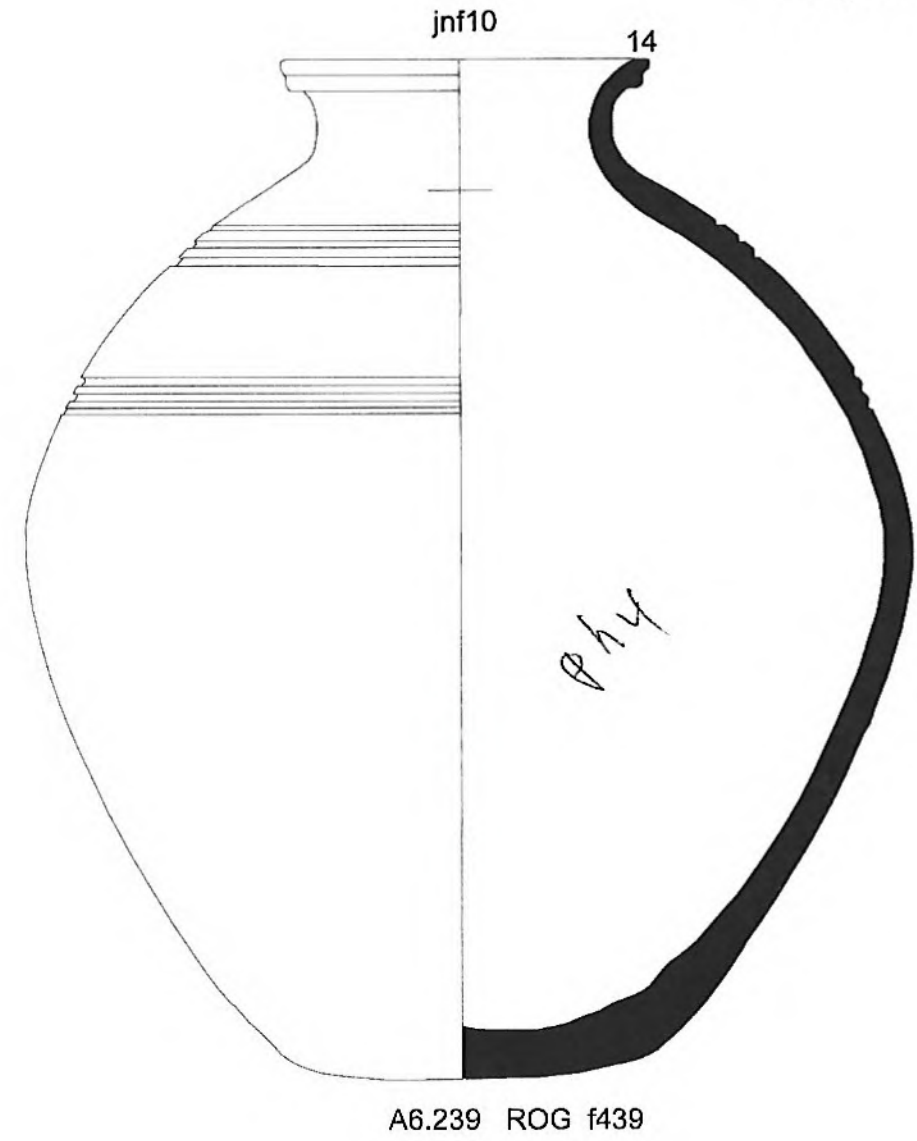
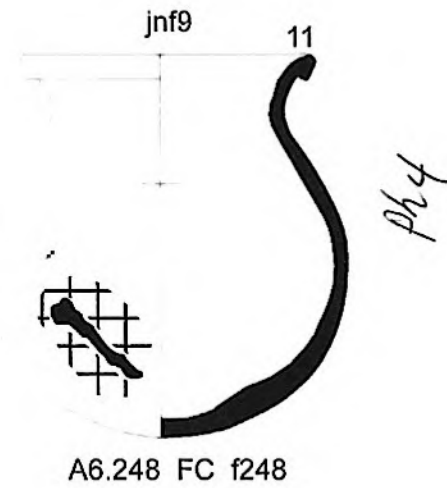
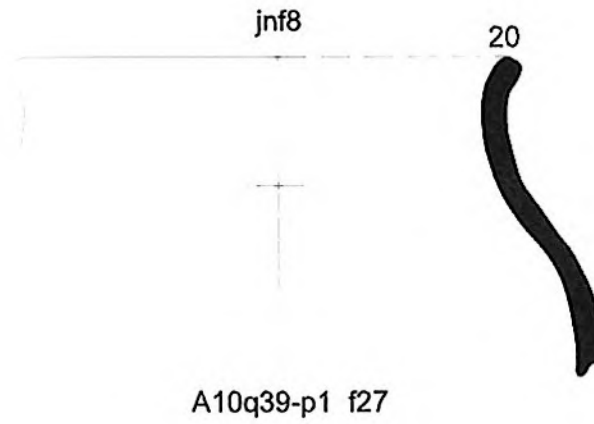
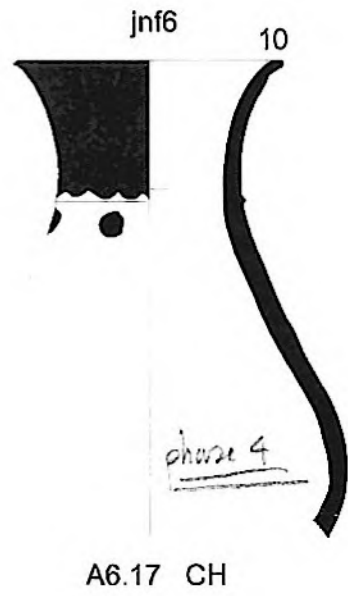

Straight Neck Jars

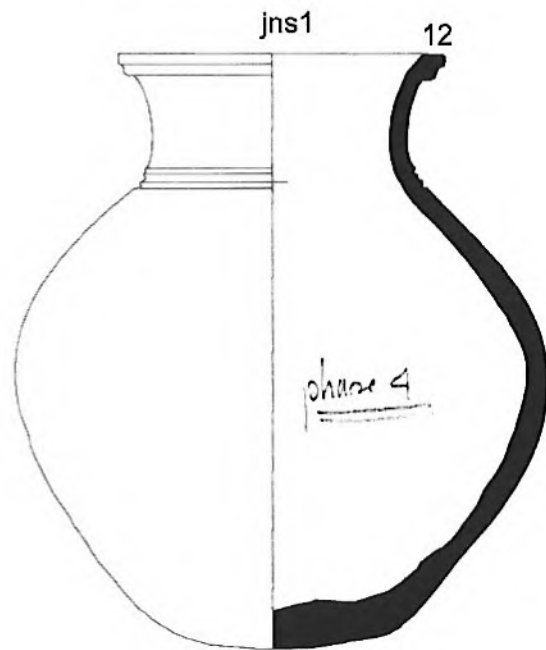

A10.10 CH f27

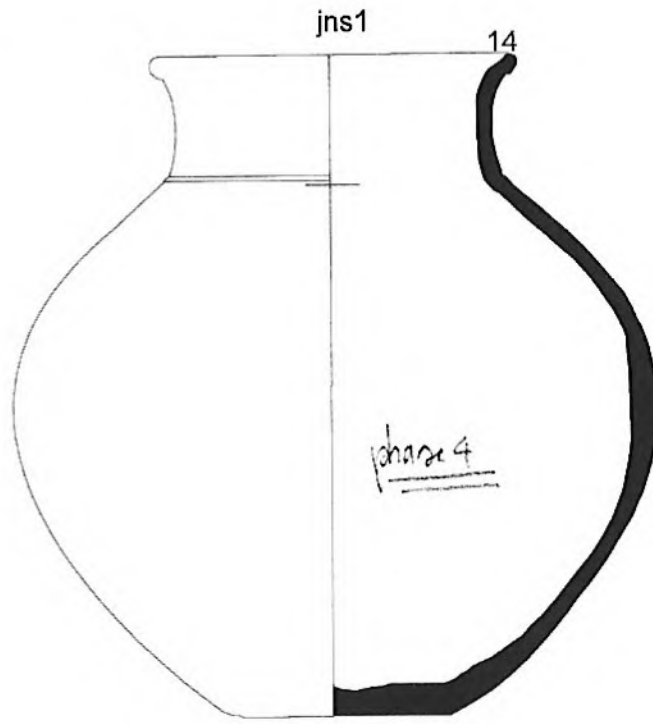

A2.137 CH f138

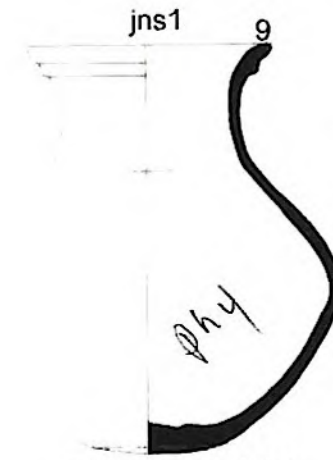

A6.52 CH f108

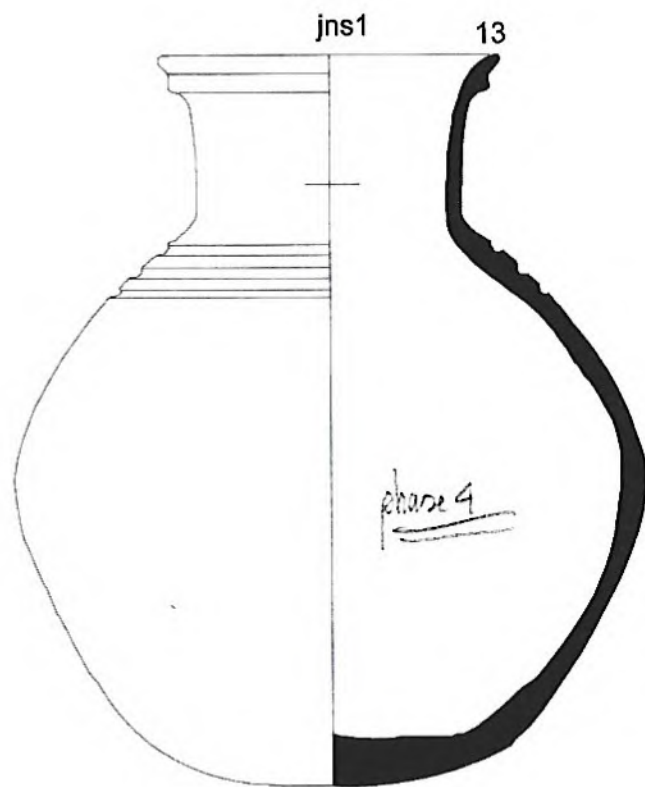

A10.7

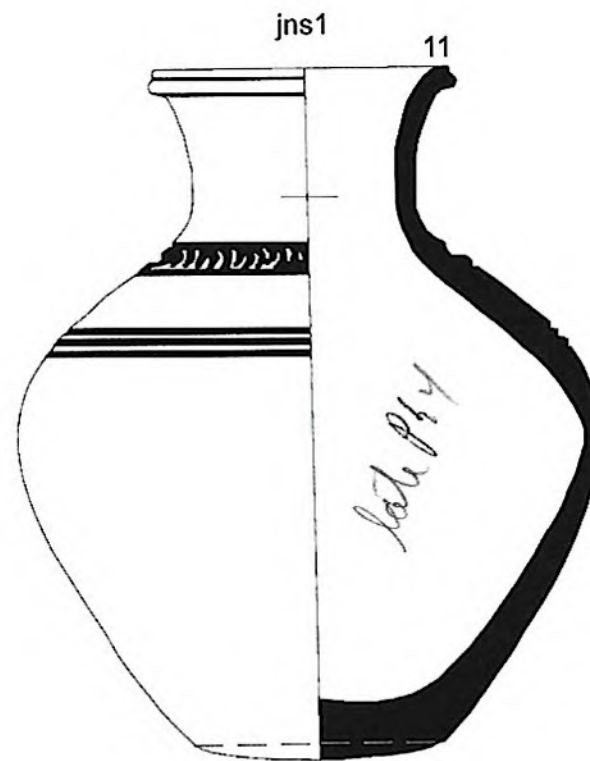

A6.240 INC f439

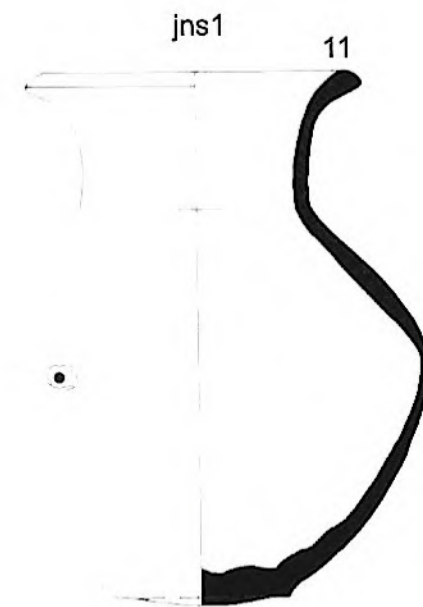

A10.85 CH f133

Straight Neck Jars

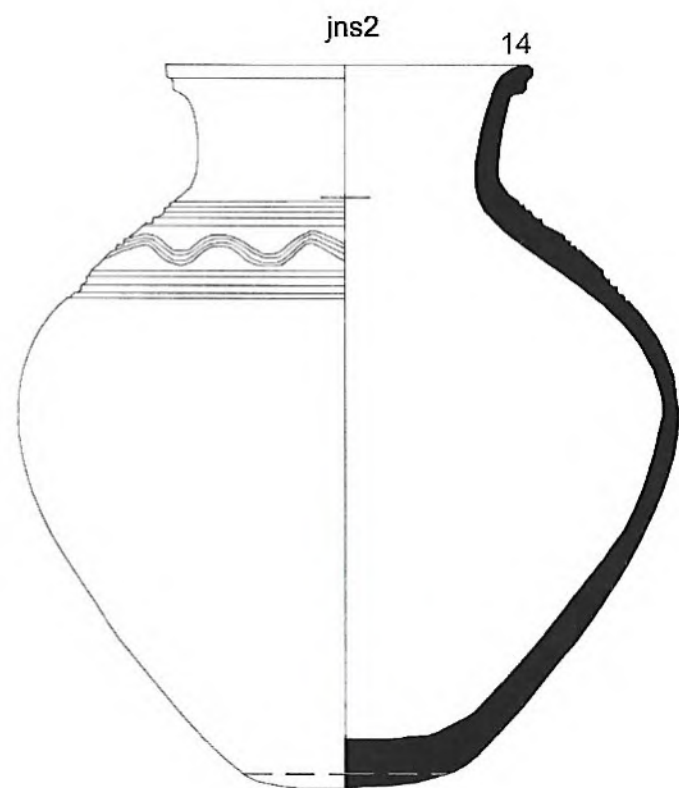

A7q903.2 f309

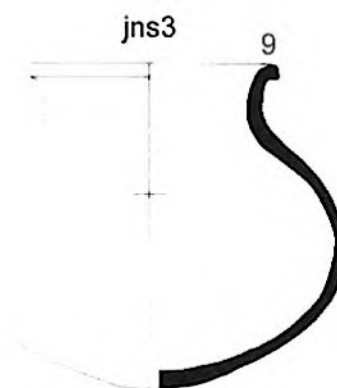

A2.147 S f181

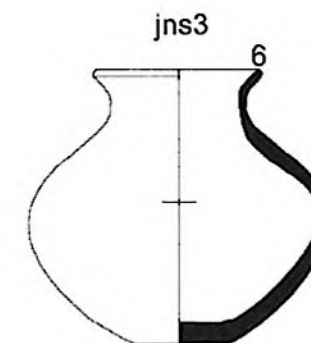

A9.8 ROG f36

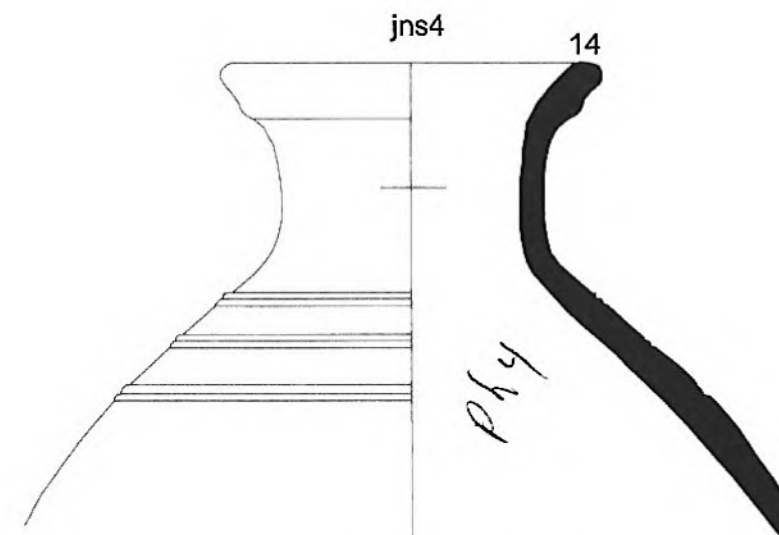

A7.385 INC f266

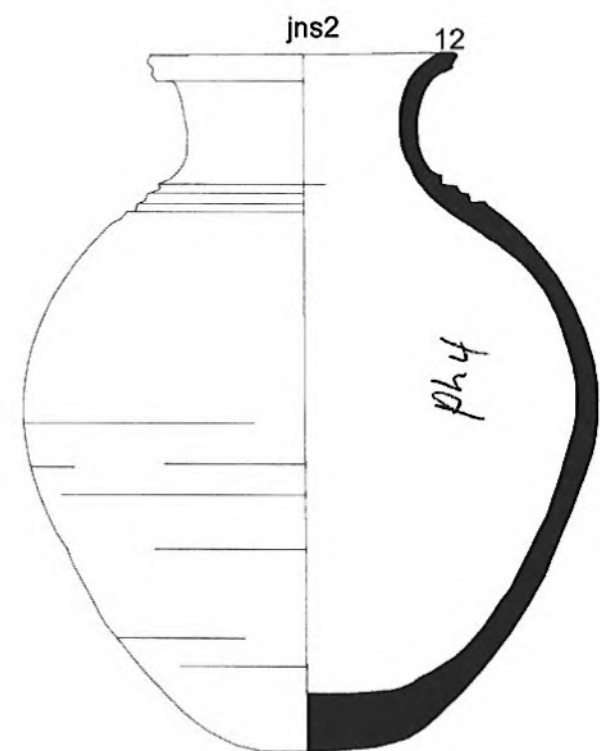

A10.109 CH f102

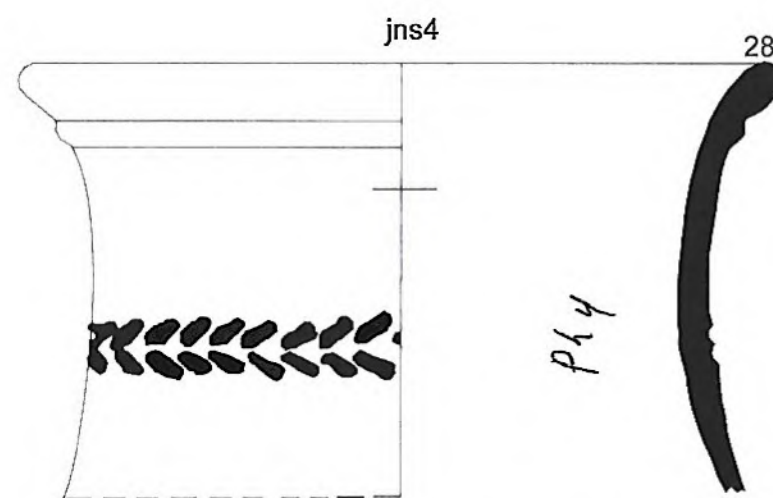

A10q253.2-p1+2 INC

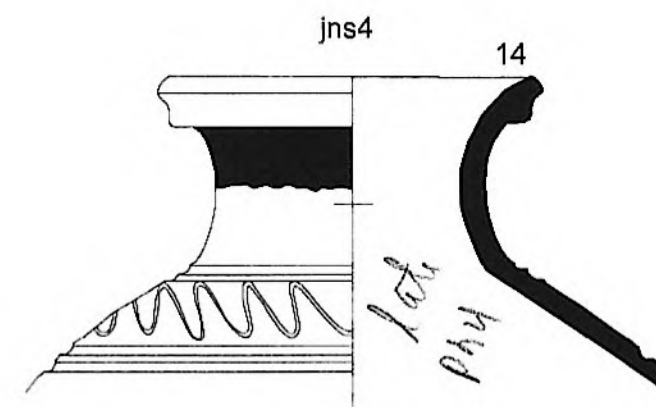

A7q269 INC f78

Straight Neck Jars

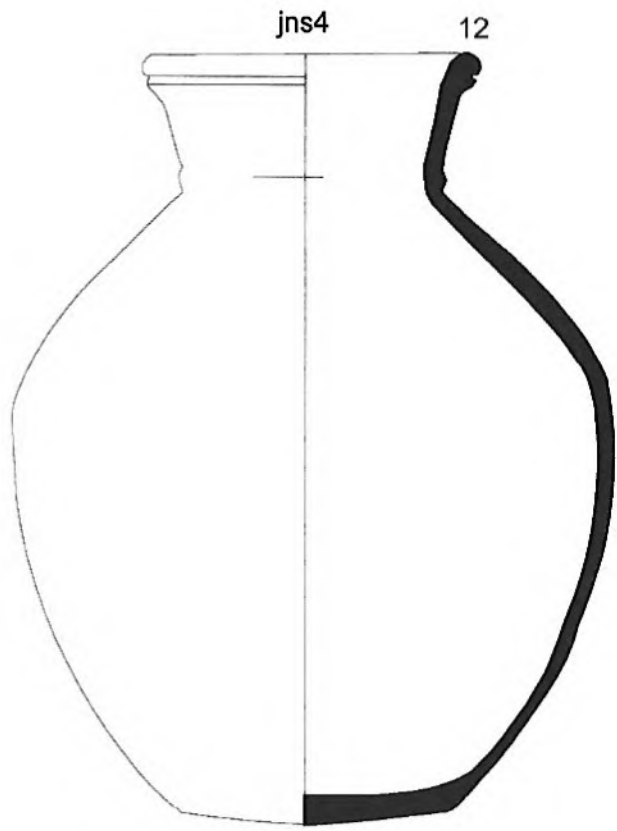

A10.46 CH f94

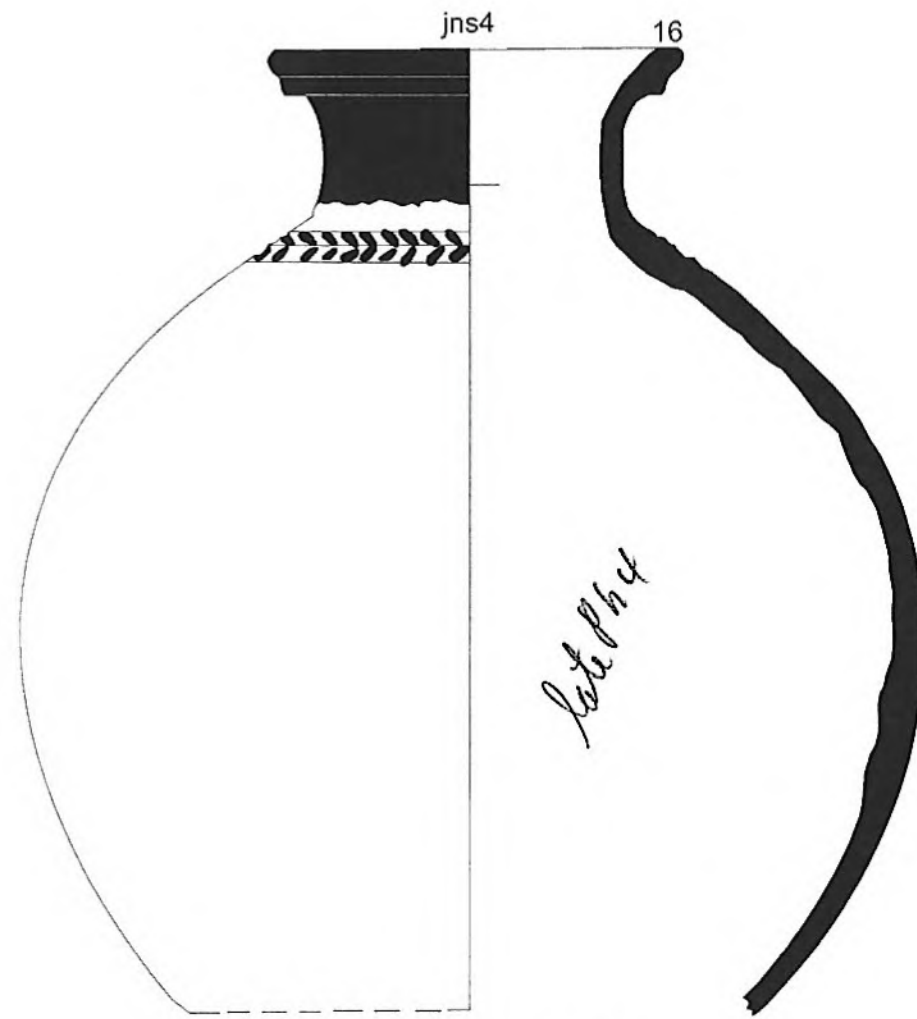

A2.127 INC f121

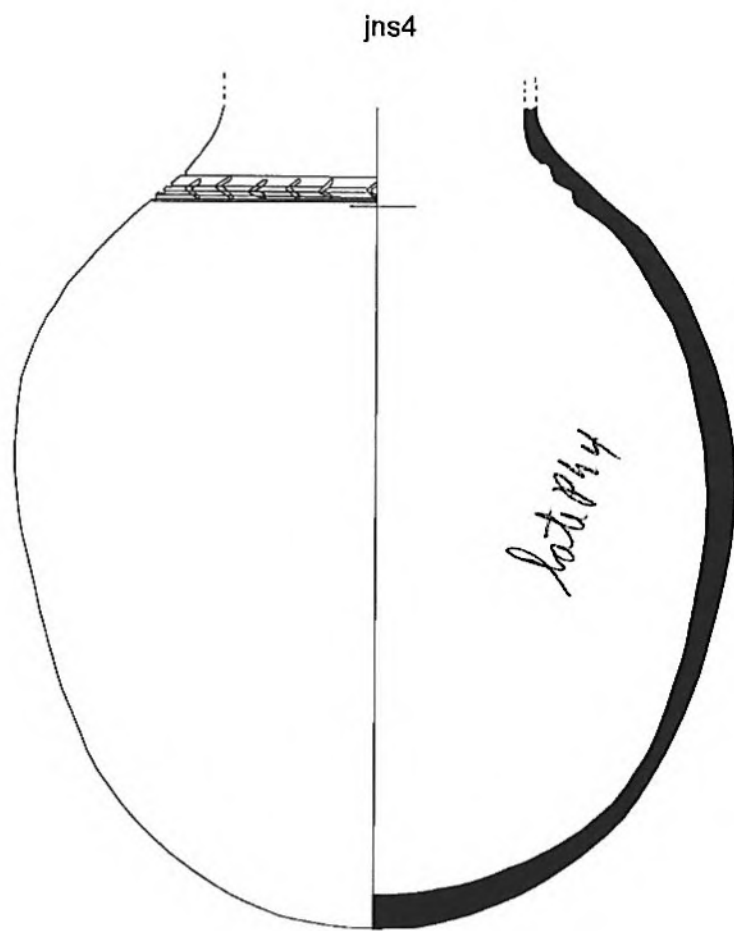

A2.2 F

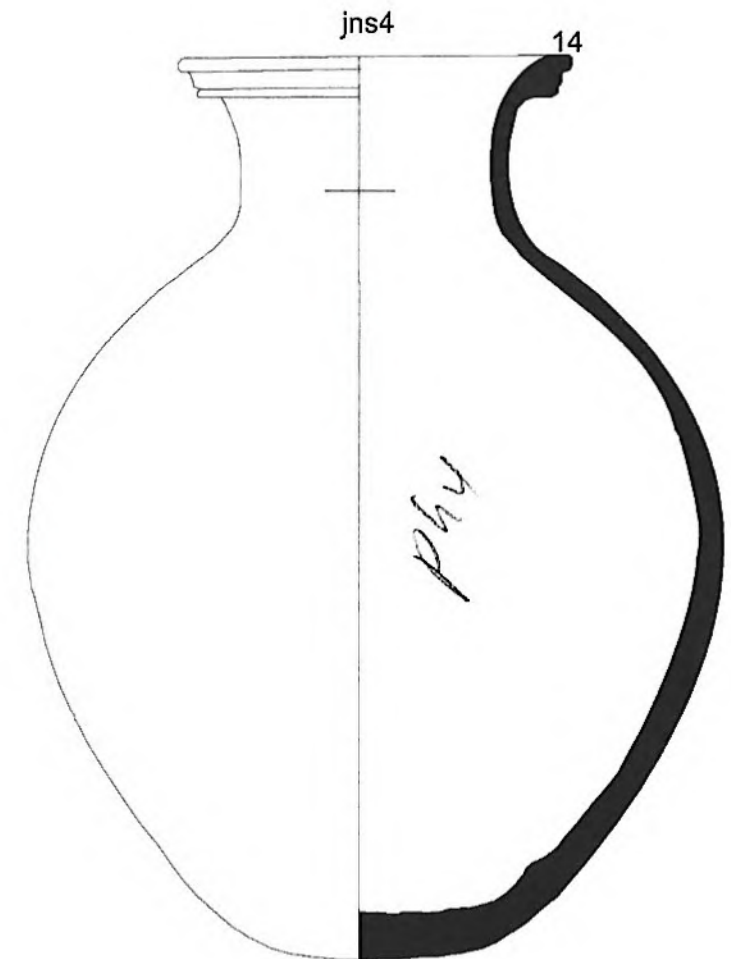

A2.128 CH f121

Straight Neck Jars

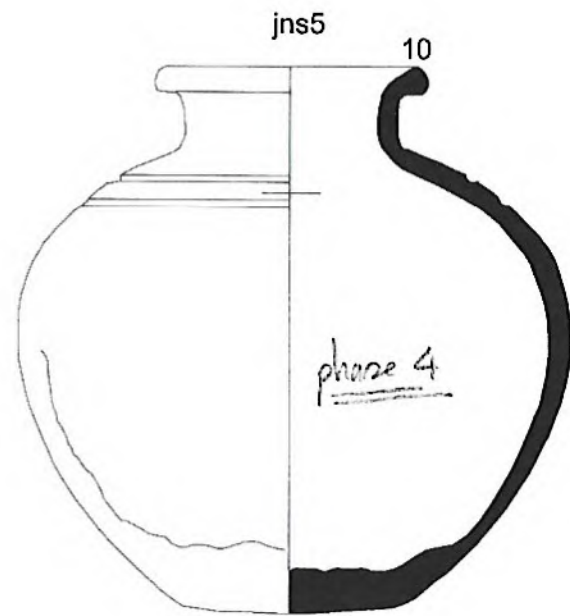

A2.149 CH f181

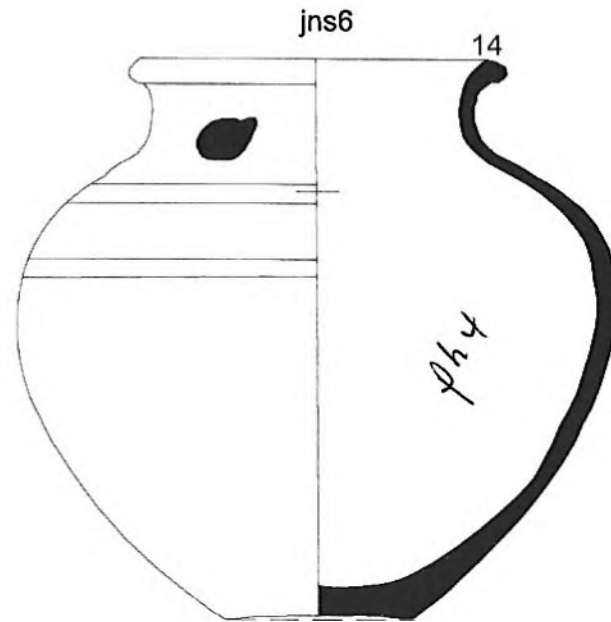

A7.328 f192

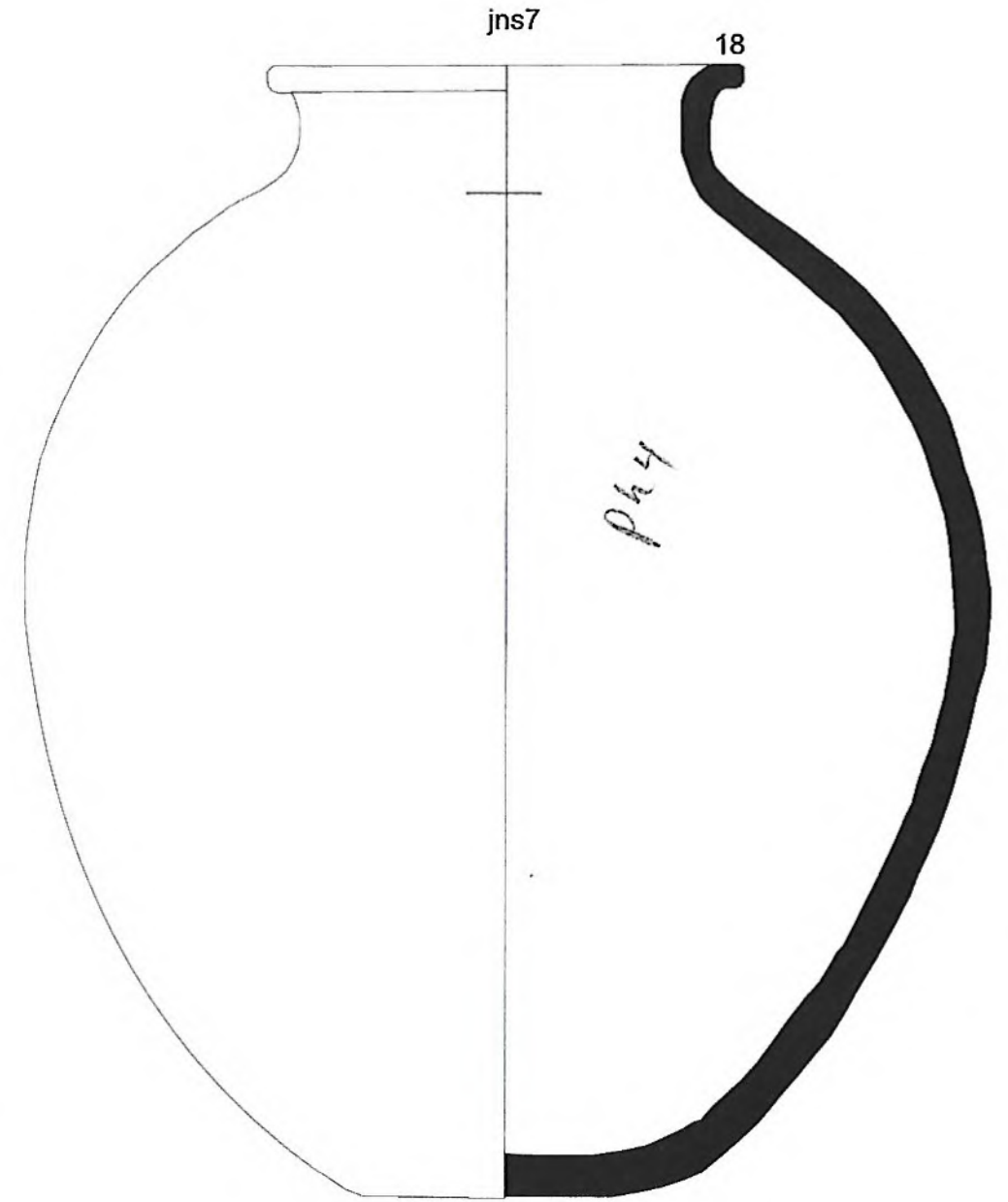

A5.9

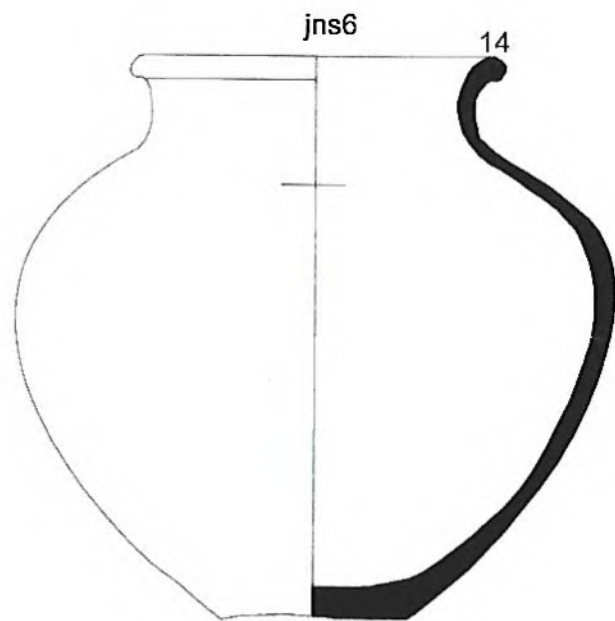

A2q297.1 f119

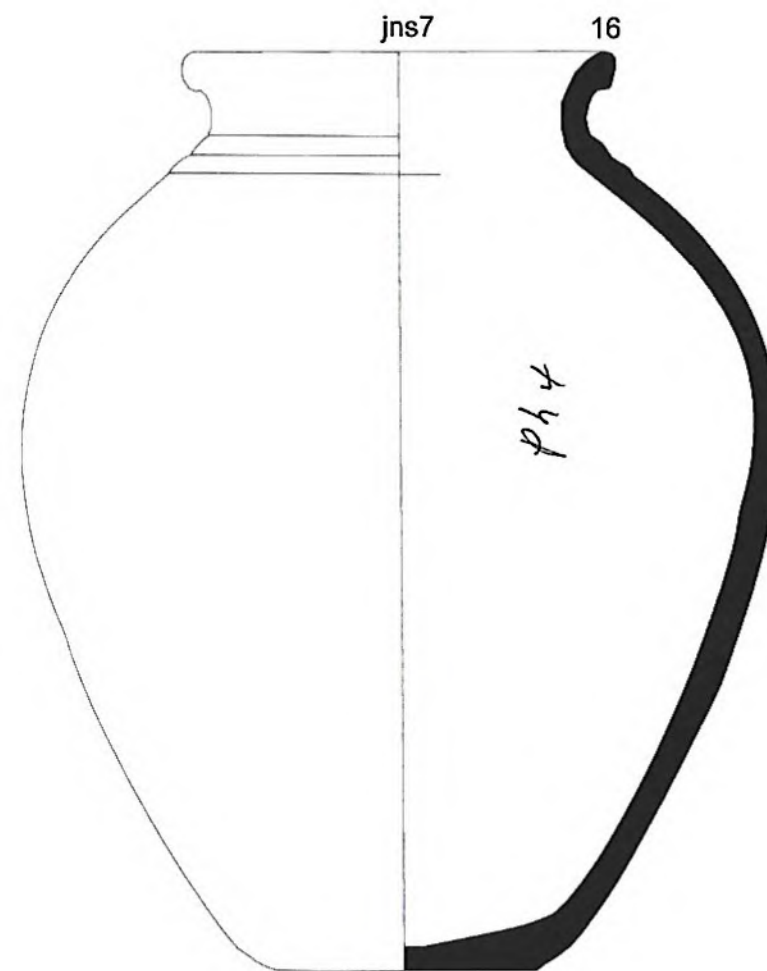

A5q345 CH

Straight Neck Jars

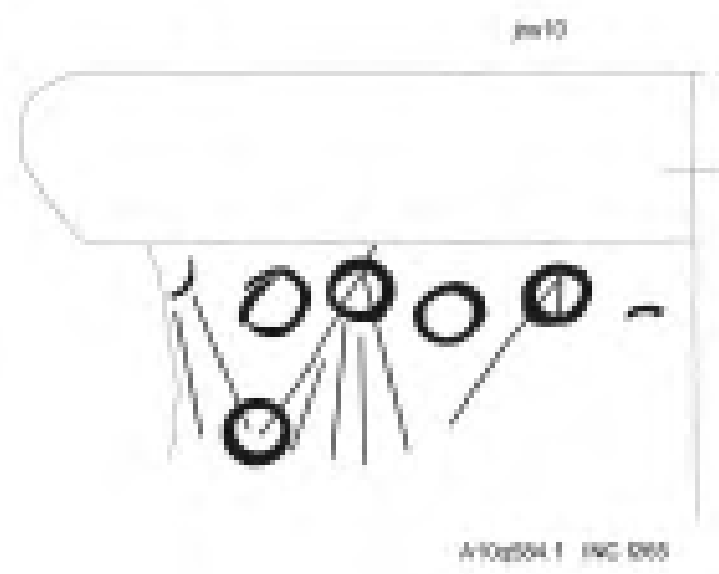
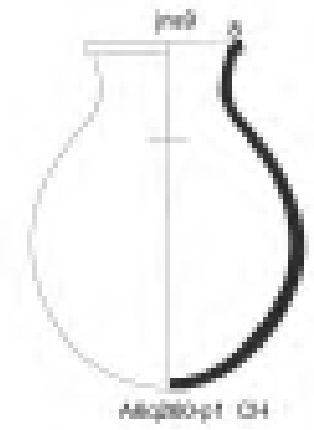
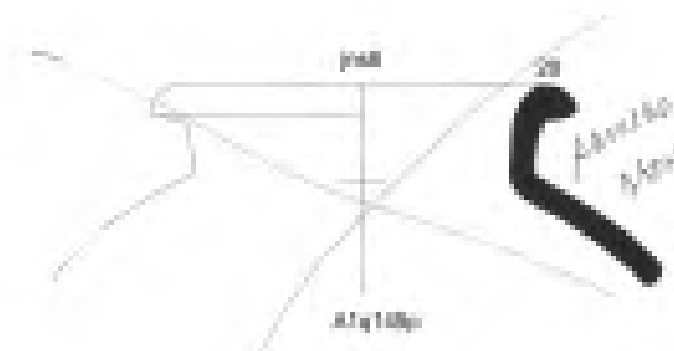
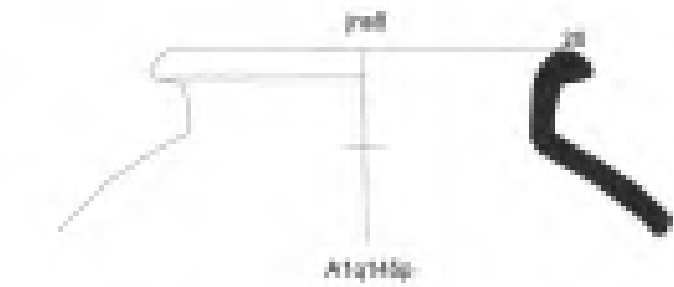
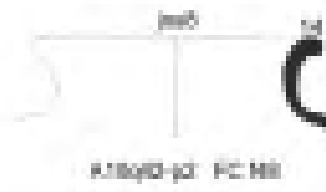
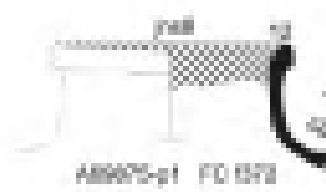

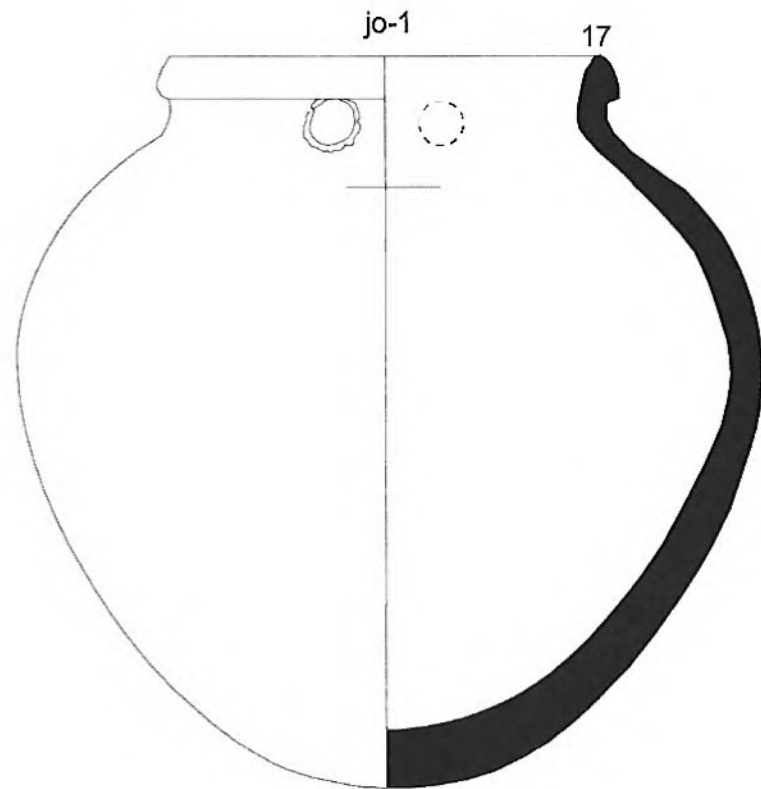

A10.90 CH

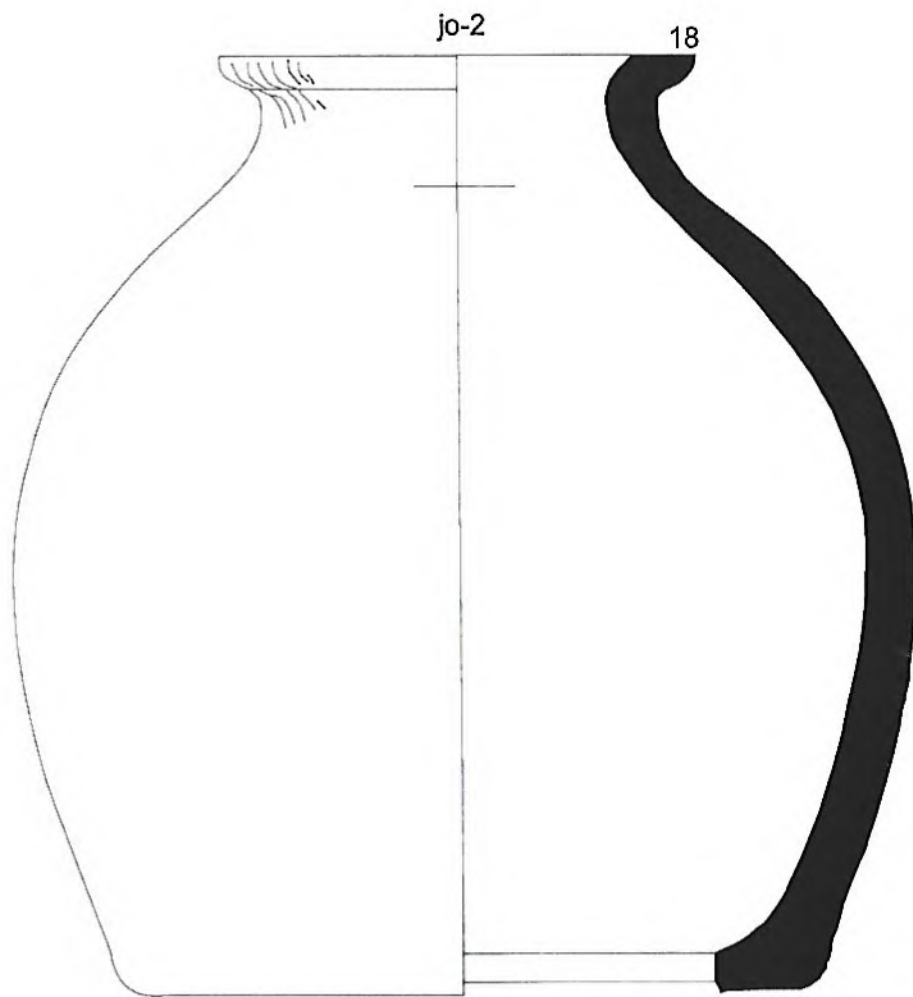

A5.33 CH

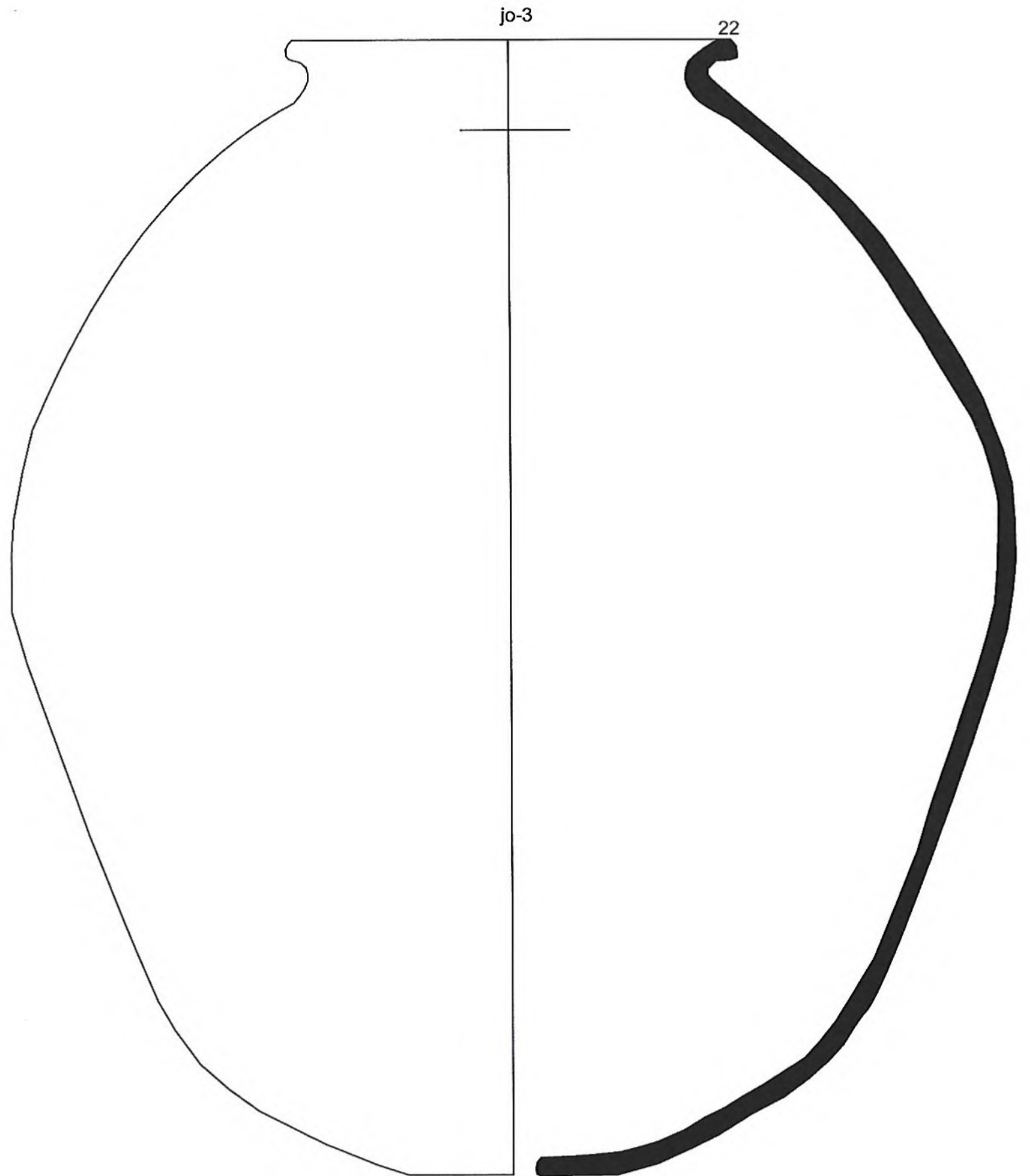

A7q409-p1 CH

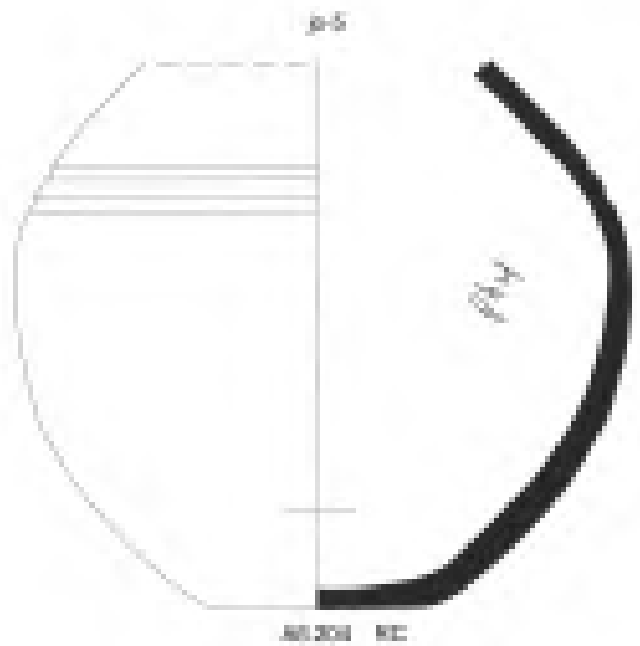
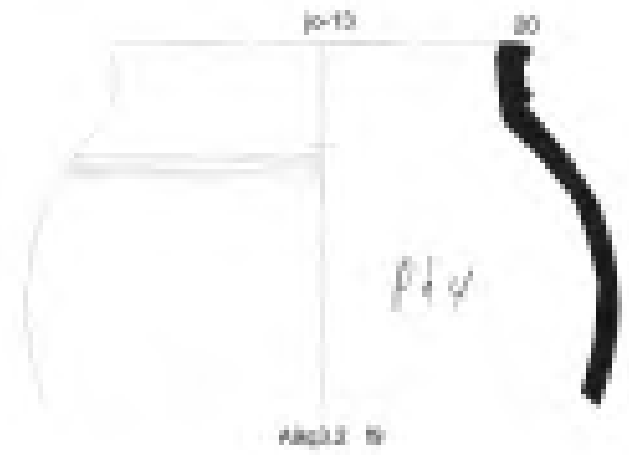
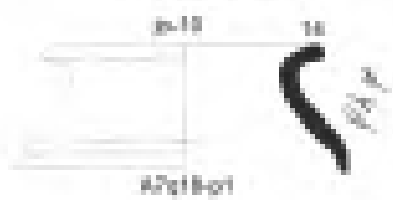
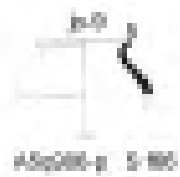
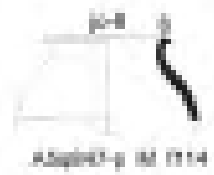

Other Jars



A1160204-p1 FC 1164



A1160204-p1 P 121



A1160204-p1 P 122



A1160204-p1 R000 1117

*R726
OK g...
for patches in
P. 4/10/07*

Other Jars

Hand drawn



A10q208-p1 140 1125

Hand drawn

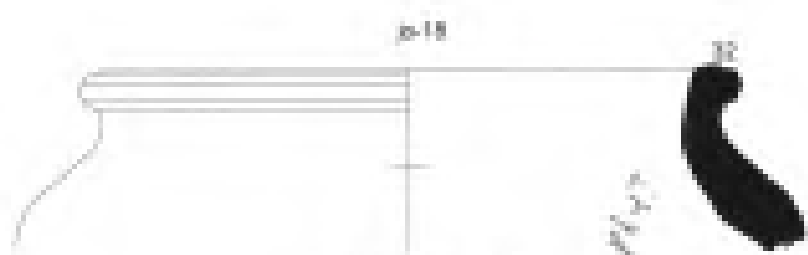

A8q203 BR 1104

Hand drawn



A7q1.3 CH

Hand drawn



A0.2 FC

Hand drawn

*R 705
j0-27
Col. P1-11-14*

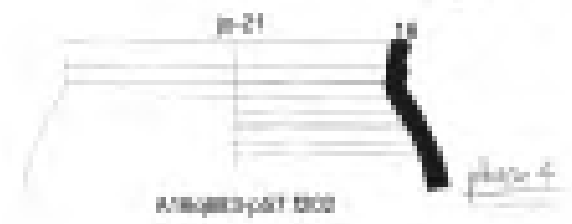

A18q203-p01 1100

Hand drawn



A14q143-p2 1004

Hand drawn



A18q203-p03 1007

Hand drawn

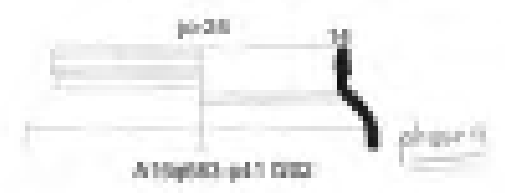

A10q203-p11 1000

Hand drawn



A10q203-p04 1002

Hand drawn



A18q203-p00 1000

Hand drawn

Other Jars - Shouldered

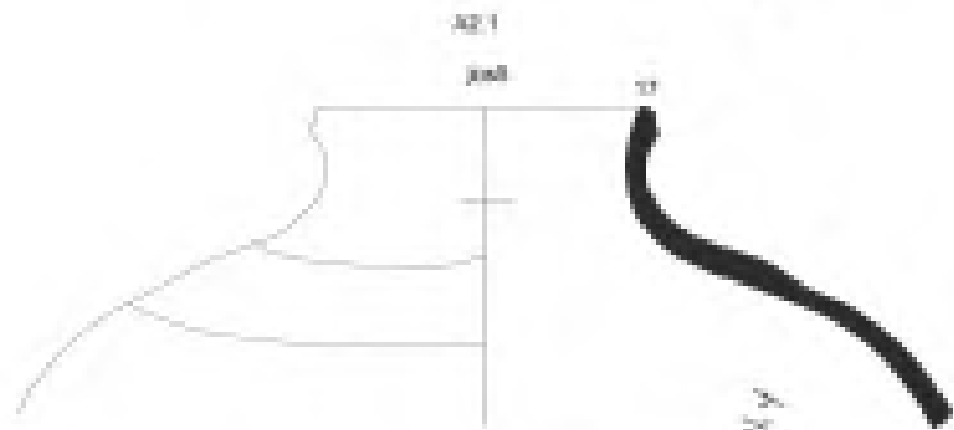
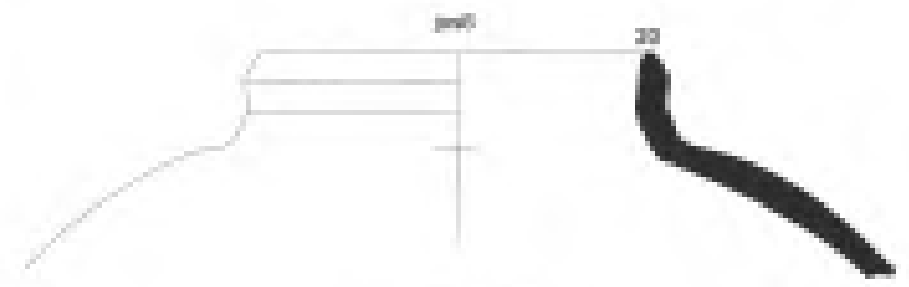
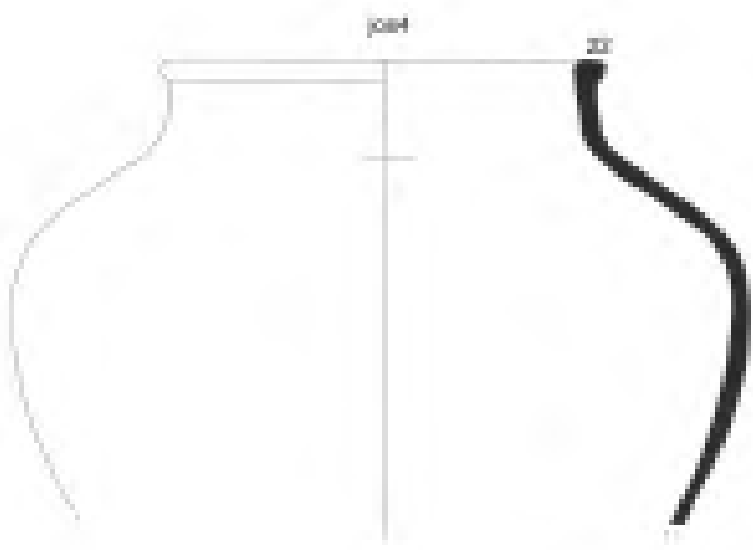

AT.288 CH



AT.281 S



AT.278 NW

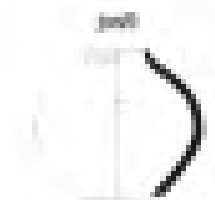

AT.272 NW SW

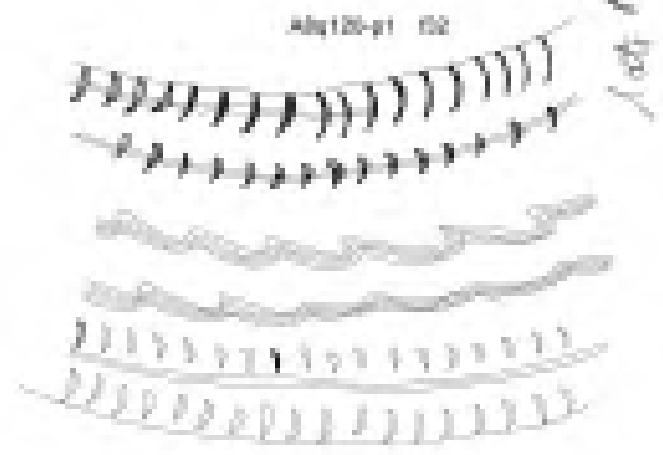

Other Jars - Shouldered

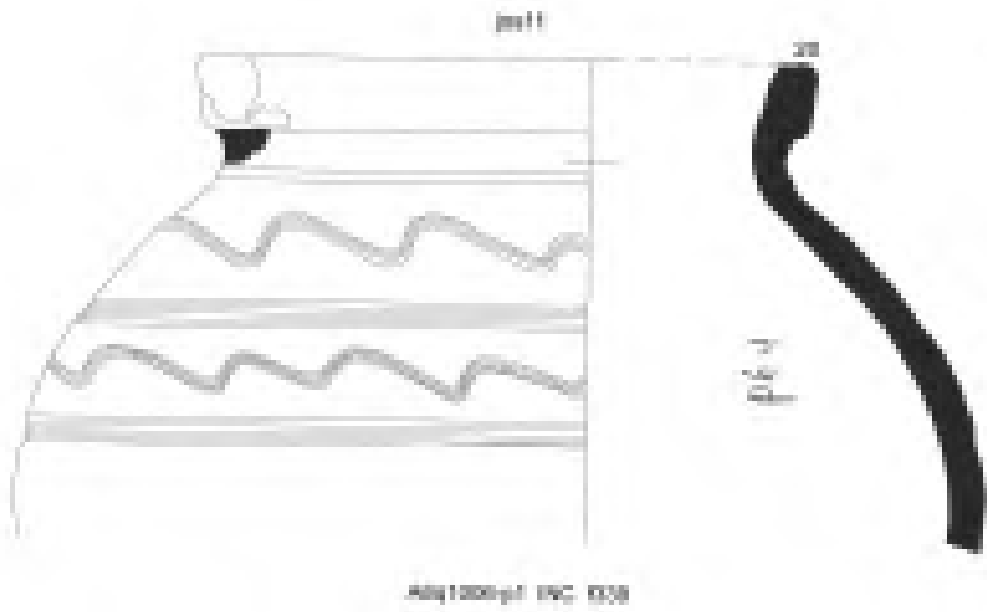

HOLE
Whole Mouth Jars

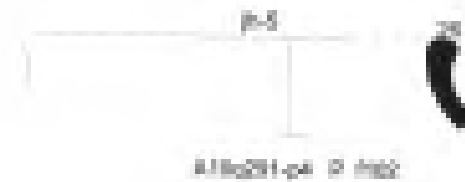
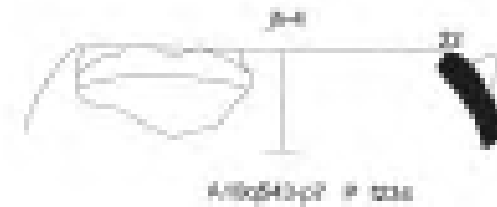

*Photo in the bottom of jar is
how it is p. 13*

HOLE
Whole Mouth Jars

Other Vessels

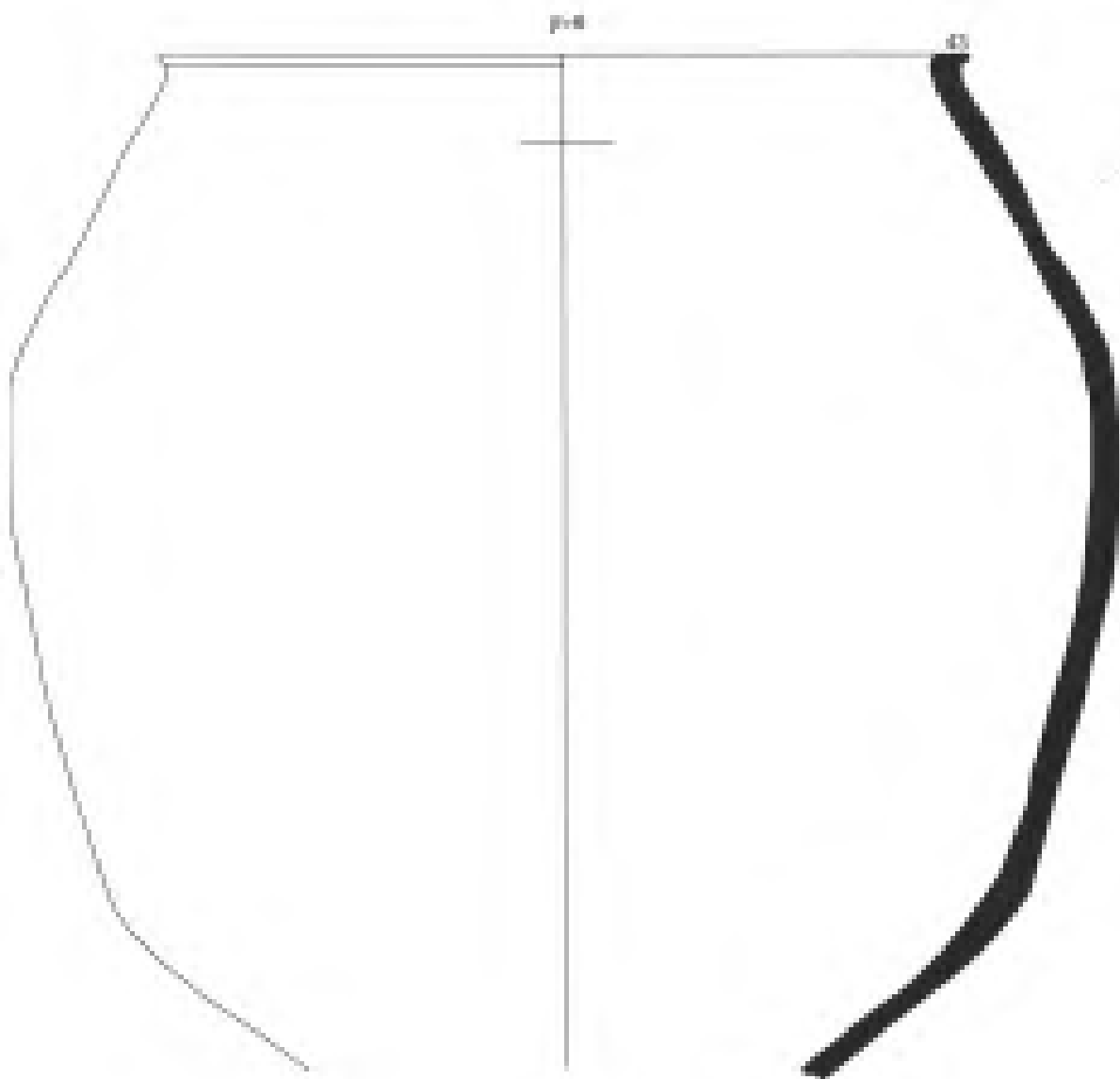

A10q143



A17q88



A17AQ2 CH 008



A18q143-p18 FC 80

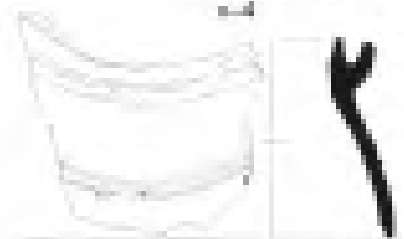

A17q88-p1 BK 1120

R726
Ch. 8/10
p. 51
2852
2852

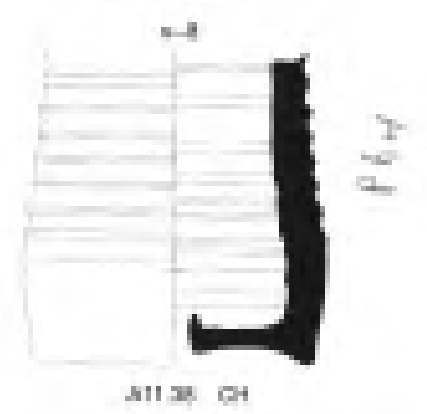
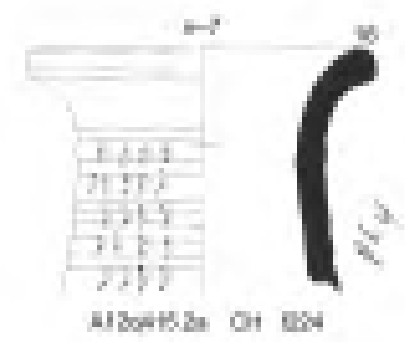
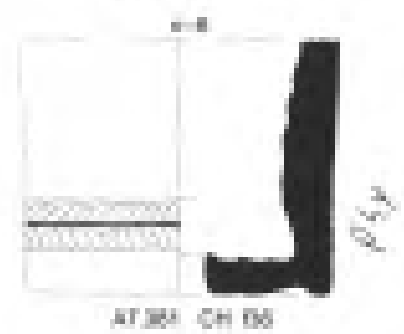

Pots

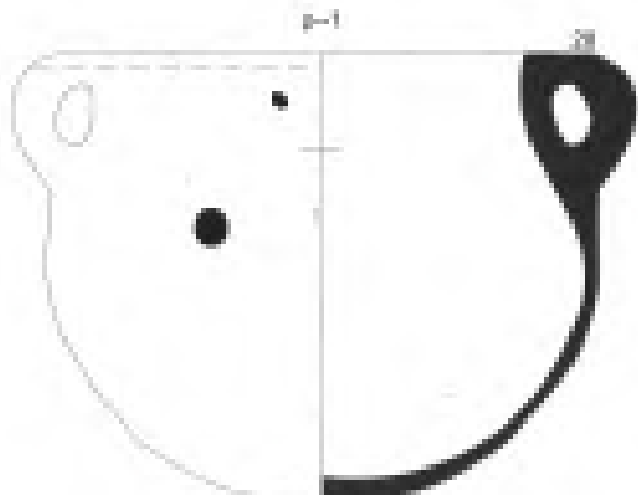

A2176 P 116



A1q228-p S 115

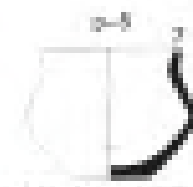

A1q188-4 POC 107



A1q307-p4 118



A6q265.1 CH 141



A1q203-p CL 117



A6q268.1 POC 142



A1q181.1 CH



A1q142-p1 CH 119

RT 15
p = 10
A21 p4 + cut.

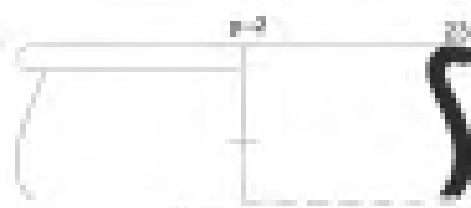

A1q228-p P 113



A5q128 S 114



A1q208-p CH 112



A18q42-p1 143

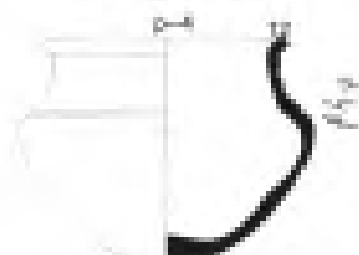

A1072 CH 129

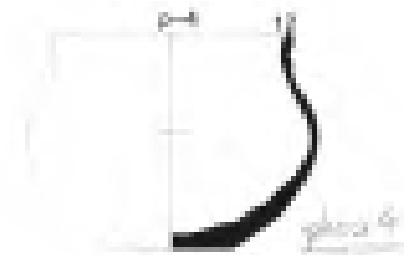

A10q175.1 CH

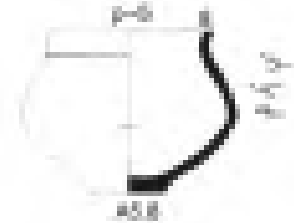

A2.2



A1q274-p1 P2 141

Bottles

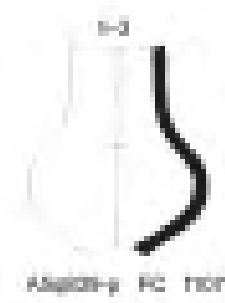

Conical Cups

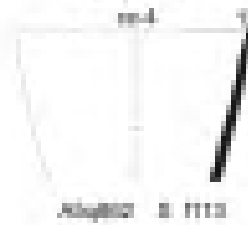
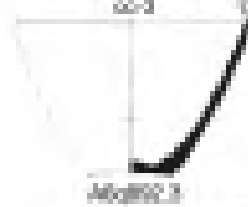
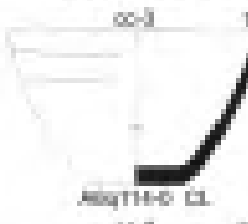
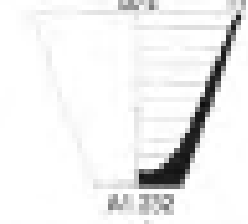
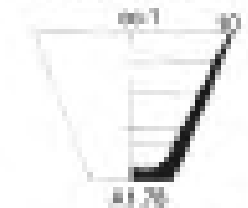

Other Cups

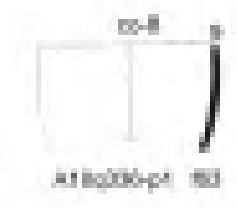
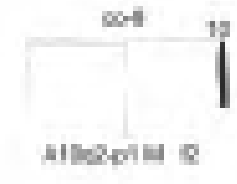
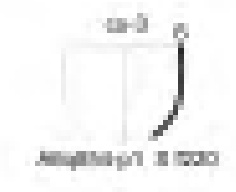
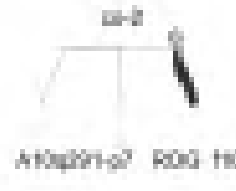
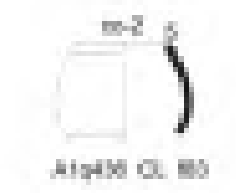
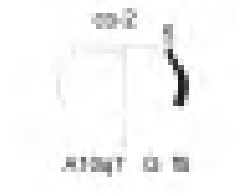

b = Axial run (i.e. split or pointed rim)

Rim Types Phases 2-5

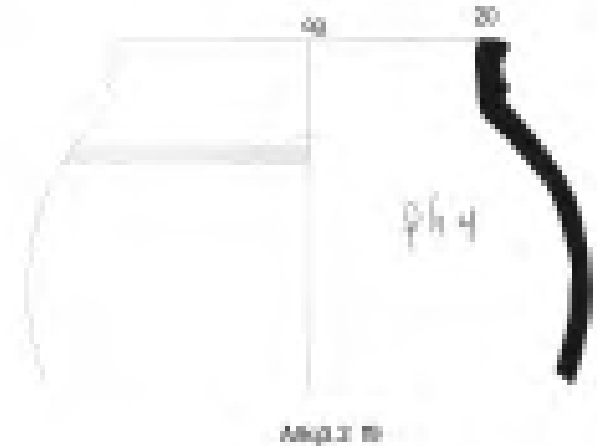
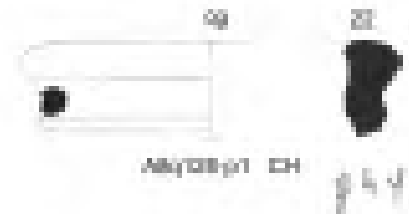
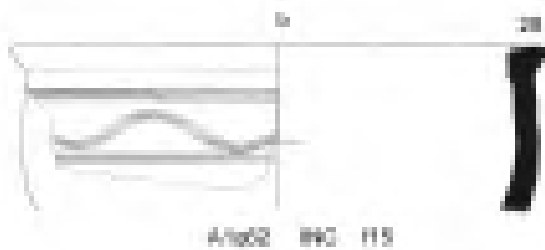
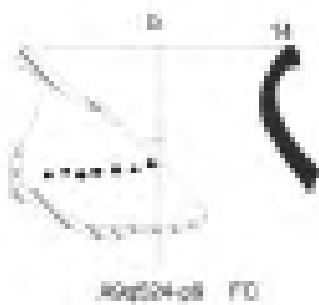
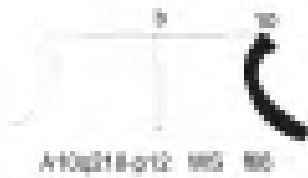

R726
 Acol CH = double parallel
 rims

Rim Types

double rim top rim rounded
 bottom rim pointed



A8q20-c2 CH

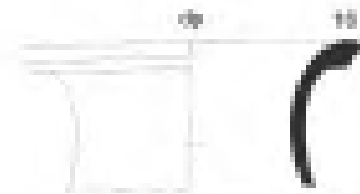

A18q284-1 CH 1139

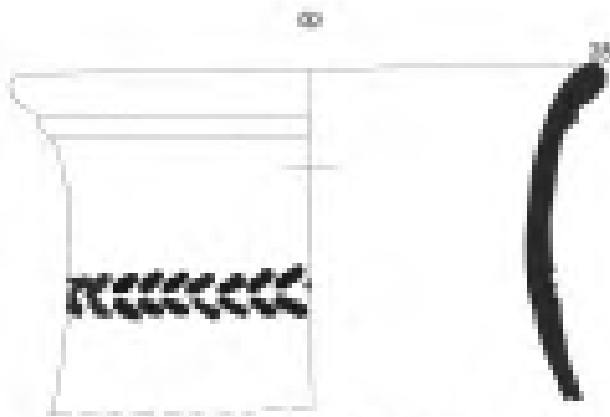

A10q210.2-p1-2 140

flaring rim

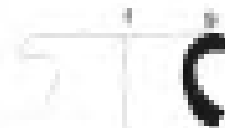

A18q277-c1 CH 1038



A10q280-p1 MCO 1138



A8q218 15 1104



A10q24-c2 P 140

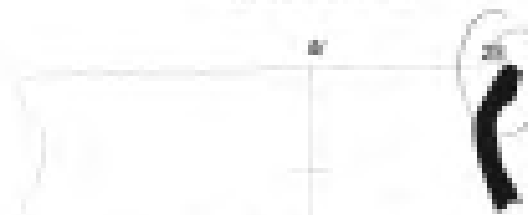

A10q287-c3 RCO 1118

exterior ground rim

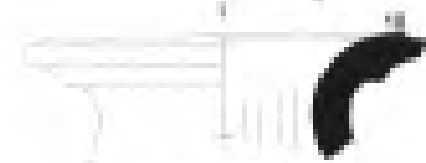

A8q185 CH

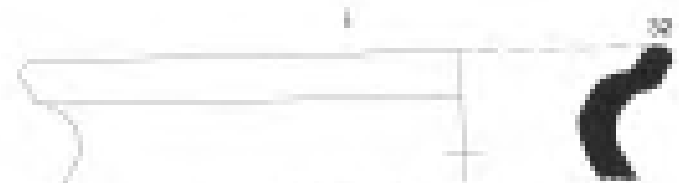

A7q284-p1 CH 1018

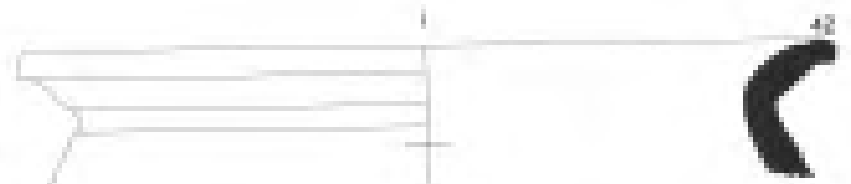

A7q213 CH 1113

R726
 Acol CH = double parallel
 rims

interior thickness

Rim Types - page 3

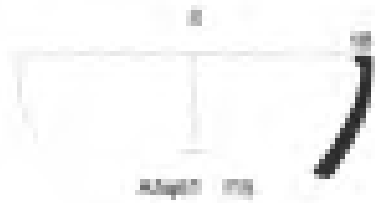

Rim Types

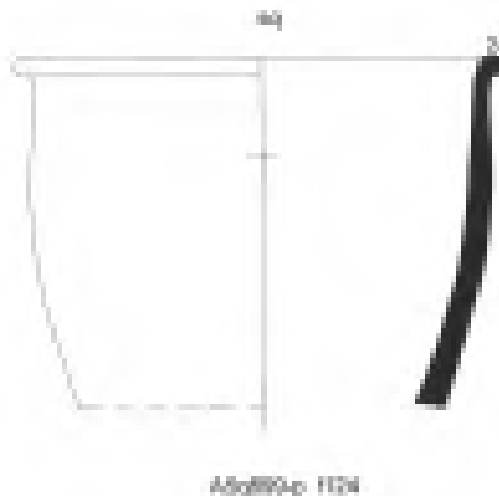
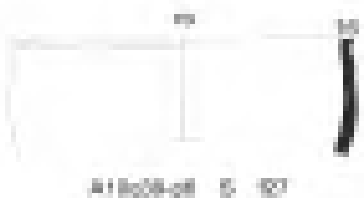
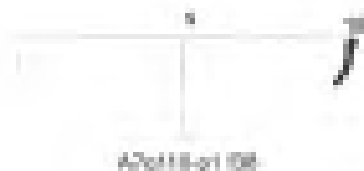

pk4



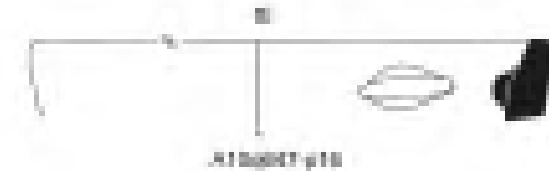
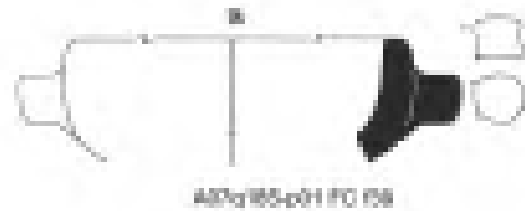
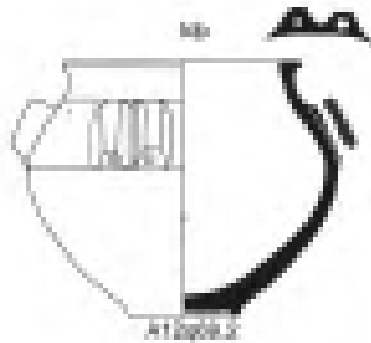

tr- round handle, near rim of bowl

tss- simple handle (single)
A16q148-p7 E21

ts- handle semi-circular exterior and
tsi- handle semi-circular interior

tos- handle oval in section

tst- strap handle rectangular in section

Bases Phases 2-5

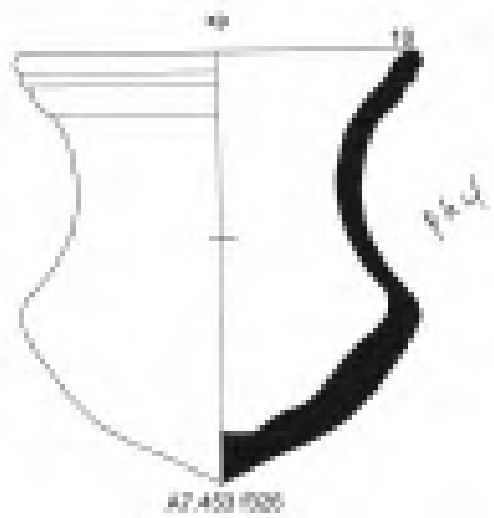
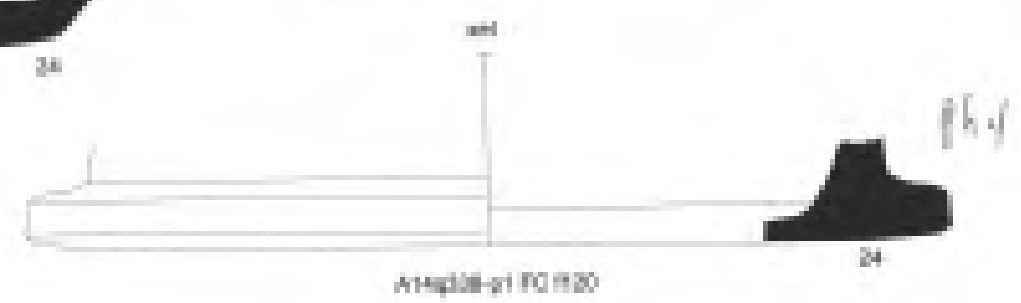
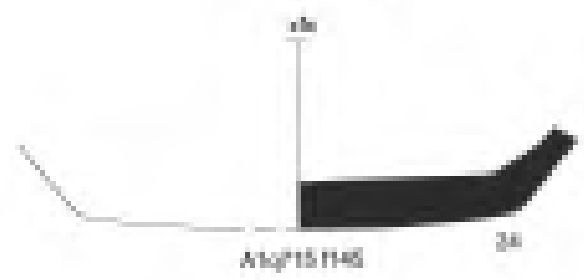
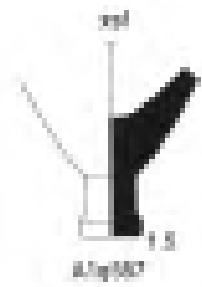
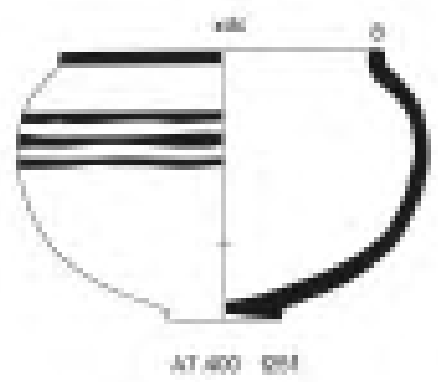
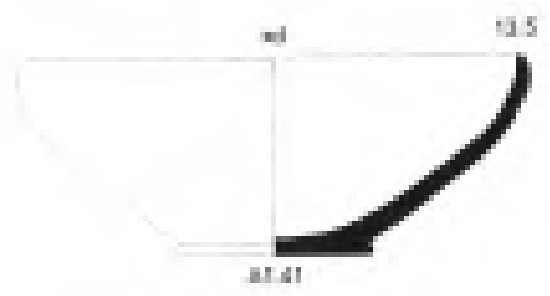
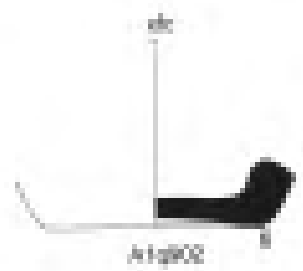

Bases

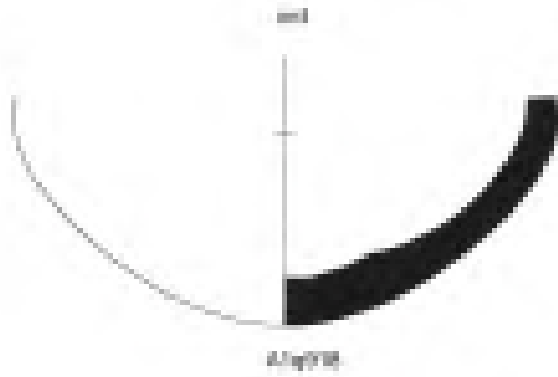

A14q976

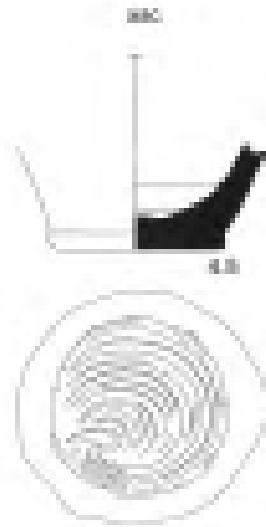

A14q111-p11 022

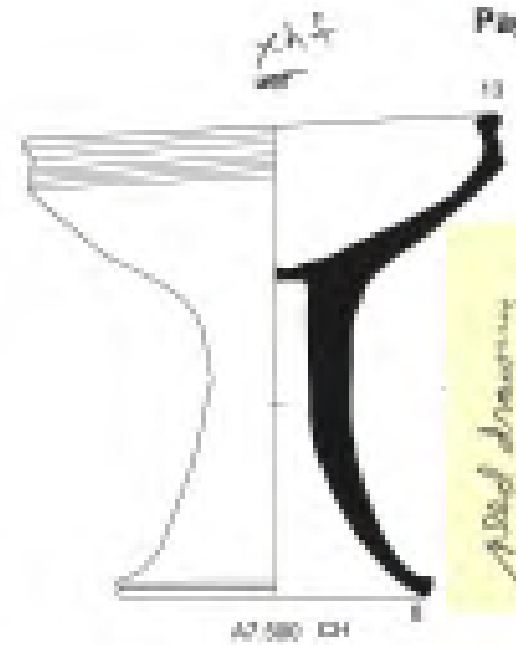

A7 580 CH

Added drawing of 580 (being added) low table from: A7 580

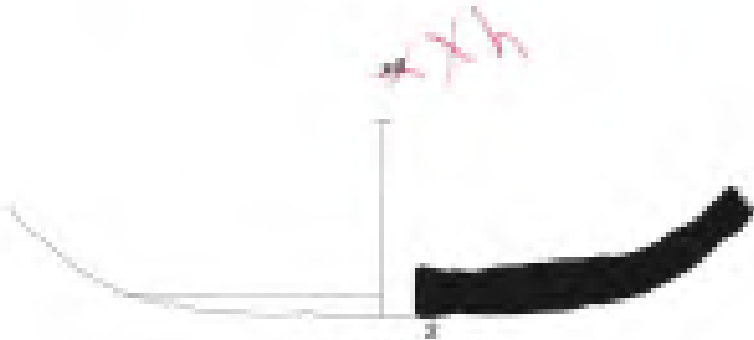

A14q536-p11 1194

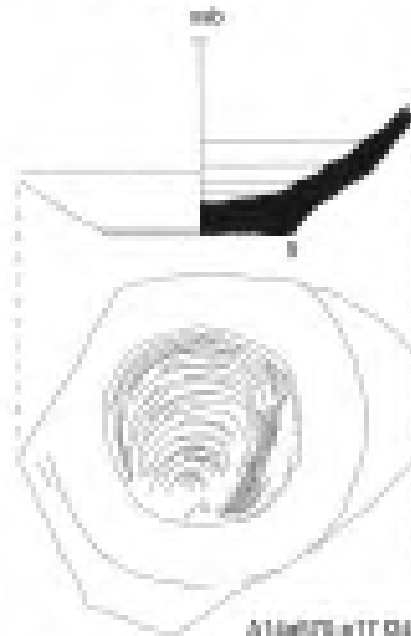

A14q976-p11 021

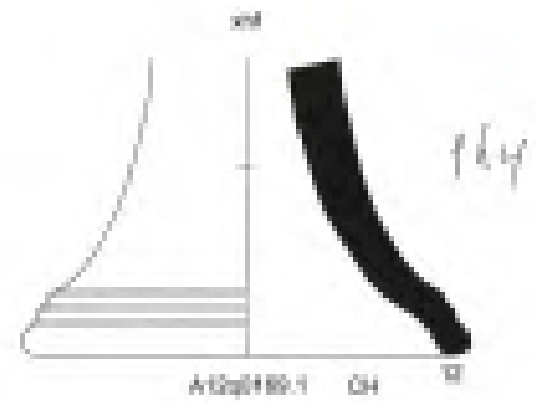

A12q1189-1 CH



A14q476-p12 001

Problems with measurements 2006

